

R-580D
MODELS **R-580D(K)** (J)

SHARP

WARRANTY

Consumer Electronic Products

Congratulations on Your Purchase!

This Sharp product is warranted against faults in materials and manufacture for a period of twelve (12) months from the date of original purchase.

If service is required during the warranty period, please contact your nearest Sharp Approved Service Centre. These repairs would be carried out at no charge to the owner, subject to the conditions specified herein.

The owner is responsible for any transportation and insurance costs if the product has to be returned for repair.

This warranty does not extend to accessories or defects or injuries caused by or resulting from causes not attributable to faulty parts or the manufacture of the product, including but not limited to, defect or injury caused by or resulting from misuse, abuse, neglect, accidental damage, improper voltage, liquid spillage, vermin infestation, software, or any alterations made to the product which are not authorised by Sharp.

Please retain your sales documentation, as this should be produced to validate a warranty claim.

This warranty is in addition to and in no way limits, varies or excludes any express and implied rights and remedies under any relevant legislation in the country of sale.

IMPORTANT

DO NOT RETURN THIS PAGE TO SHARP

For your reference, please enter the particulars of your purchase below and retain, with your purchase documentation.

Model No. _____

Serial No. _____

Date of Purchase _____

Retailer _____

FOR LOCATION ENQUIRIES WITHIN

AUSTRALIA

REGARDING YOUR
LOCAL

SHARP APPROVED SERVICE CENTRE
CALL THE
SHARP SERVICE REFERRAL CENTRE
TOLL FREE 1 300 135 022

DURING NORMAL BUSINESS HOURS
(Eastern Standard Time)

or contact our web site
www.sharp.net.au

SHARP CORPORATION OF AUSTRALIA PTY. LIMITED
ABN 40 003 039 405
1 Huntingwood Drive Blacktown NSW 2148

FOR PRODUCTS PURCHASED IN

NEW ZEALAND

CONTACT YOUR SELLING DEALER/RETAILER
OR CALL

SHARP CUSTOMER SERVICES
telephone: **09 573 0111**

FACSIMILE: 09 573 0113

or contact our web site
www.sharpnz.co.nz

SHARP CORPORATION OF NEW ZEALAND LIMITED
59 Hugo Johnson Drive
Penrose, Auckland

IMPORTANT NOTICE: This warranty applies only to products sold in Australia & New Zealand.

INTRODUCTION

SHARP®

INFO DISPLAY COOKING SYSTEM

Thank you for buying a Sharp Microwave Oven. Your new oven has an "Information Display System" which offers you step-by-step instructions to easily guide you through each feature.

Your oven also has a HELP key for instructions on using Auto Start, Demonstration Mode, Child Lock, Info on Pads and Help.

We strongly recommend however that you read this operation manual thoroughly before operating your oven, paying particular attention to the safety warnings and special notes.

The manual is divided into two sections:

1. OPERATION (P2~P20)

This section describes your oven and teaches you how to use all the features.

2. COOKING GUIDE

This section is at the back of the manual, it contains the more commonly used information such as how to prepare food, which cooking utensil to use, standing time.

It also contains recipes for automatic cooking and manual cooking.

Please take some time to read your operation manual carefully, the automatic cooking menus programmed into your new oven have been carefully developed to give optimum results when the step-by-step instructions are followed.

When selecting another home appliance, please again consider our full range of Sharp products.

CONTENTS page

Warranty	Inside of front cover
Introduction	1
Warning	2
Special Notes	3
Installation Instructions	4
Oven Diagram	4
Operation of Touch Control Panel	5
Control Panel Display	5
Touch Control Panel Layout	5
Before Operating	6
Getting Started	6
Clock Setting	6
Stop/Clear	6
To Cancel a Programme	6
Manual Operations	7
Microwave Time Cooking	7
Sequence Cooking	8
Instant Cook	8
Increasing Time	9
Slow Cook	10
Automatic Operations	11
Notes for Automatic Operations	11
Sensor Instant Reheat	11
Sensor Cook	12
Express Defrost	13
Easy Defrost	14
Other Convenient Features	15
Help Feature	15
Less/More Setting	18
Timer	19
Alarm	19
Care and Cleaning	20
Service Call Check	20
Specifications	20
Cooking Guides	① - ⑳
Quick Reference Guide	See last page

WARNING

Read all instructions before using the appliance.

To reduce the risk of fire in the oven cavity:

- a. Do not overcook food.
- b. Remove wire twist-ties from paper or plastic bags before placing bag in the oven.
- c. Do not heat oil or fat for deep frying. The temperature of the oil cannot be controlled.
- d. Look at the oven from time to time when food is heated in disposable containers made of plastic, paper or other combustible materials for signs of smoke or burning.
- e. If materials inside the oven should ignite, or smoke is observed, keep oven door closed, turn oven off, and disconnect the power cord, or shut off power at the fuse or circuit breaker panel.

To reduce the risk of explosion and sudden boiling:

- a. Do not place sealed containers in the oven. Babies bottles fitted with a screw cap or teat are considered to be sealed containers.
- b. When boiling liquids in the oven, use a wide-mouthed container and stand about 20 seconds at the end of cooking to avoid delayed eruptive boiling of liquids.

This oven is for home food preparation only and should only be used for heating, cooking and defrosting food and beverage.

It is not suitable for commercial, laboratory use, or heating therapeutic devices eg. Wheat bags.

Never operate the oven whilst any object is caught or jammed between the door and the oven.

Do not try to adjust or repair the oven yourself because of hazard. The oven must be adjusted or repaired by a qualified service technician trained by SHARP.

Do not operate the oven if it is not working correctly or damaged until it has been repaired by a qualified service technician trained by SHARP. It is particularly important that the oven door closes properly and that there is no damage to:

(1) Door (warped), (2) Hinges and Latches (broken or loosened), (3) Door Seals, Sealing Surfaces and oven cavity (buckled or deformed), (4) Burn marks on the door seal faces.

Do not bump, or catch utensils, loose clothes and your accessories on the door safety latches when removing food from the oven.

Never poke an object, particularly a metal object, through a grille or between the door and the oven while the oven operating.

Never tamper with or deactivate the door safety latches.

Always use oven gloves to prevent burns when handling utensils that are in contact with hot food. Enough heat from the food can transfer through utensils to cause skin burns.

Should the power supply cord become damaged, it must be replaced with a special cord supplied by a SERVICE CENTRE APPROVED BY SHARP. And it must be replaced by a qualified service technician trained by SHARP.

If the oven lamp fails please consult your dealer or a qualified service technician trained by SHARP.

Avoid steam burns by directing steam away from the face and hands.

Slowly lift the furthest edge of a dish's cover and microwave plastic wrap and carefully open popcorn and oven cooking bags away from the face.

Make sure that the power supply cord is undamaged, and that it does not run under the oven or over any hot surfaces or sharp edges.

To prevent the glass turntable from breaking:

- a. Before cleaning the turntable with water, leave the turntable to cool.
- b. Do not place anything hot on a cold turntable.
- c. Do not place anything cold on a hot turntable.

Do not place anything on the outer cabinet.

This appliance must be earthed.

Do not store food or any other items inside the oven.

Make sure the utensil does not touch the interior walls during cooking.

Only allow children to use the oven without supervision when adequate instructions have been given so that the child is able to use the oven in a safe way and understands the hazards of improper use.

This appliance is not intended for use by young children or infirm persons without supervision.

Young children should be supervised to ensure that they do not play with the appliance.

SPECIAL NOTES

	DO	DON'T
Eggs, fruits, nuts, seeds vegetables, sausages and oysters	<ul style="list-style-type: none"> * Puncture egg yolks and whites and oysters before cooking to prevent "explosion". * Pierce skins of potatoes, apples, squash, hot dogs, sausages and oysters so that steam escapes. 	<ul style="list-style-type: none"> * Cook eggs in shells. This prevents "explosion", which may damage the oven or injure yourself. * Reheat whole eggs. * Overcook oysters. * Dry nuts or seeds in shells.
Popcorn	<ul style="list-style-type: none"> * Use specially bagged popcorn for the microwave oven. * Listen while popping corn for the popping to slow to 1-2 seconds. 	<ul style="list-style-type: none"> * Pop popcorn in regular brown bags or glass bowls. * Exceed maximum time on popcorn package.
Baby food	<ul style="list-style-type: none"> * Transfer baby food to small dish and heat carefully, stirring often. Check for suitable temperature to prevent burns. * Remove the screw cap and test before warming baby bottles. After warming shake thoroughly. Check for suitable temperature. 	<ul style="list-style-type: none"> * Heat disposable bottles. * Overheat baby bottles. Only heat until warm. * Heat bottles with nipples on. * Heat baby food in original jars.
General	<ul style="list-style-type: none"> * Food with filling should be cut after heating, to release steam and avoid burns. * Stir liquids briskly before and after cooking for even heating. * Use a deep bowl when cooking liquids or cereals to prevent boiling over. * For boiling or cooking liquids see WARNING on page 2. 	<ul style="list-style-type: none"> * Heat or cook in closed glass jars or air tight containers. * Deep fat fry. * Heat or dry wood, herbs, wet papers, clothes or flowers. * Operate the oven without a load (i.e. an absorbing material such as food or water) in the oven cavity.
Canned foods	<ul style="list-style-type: none"> * Remove food from can. 	<ul style="list-style-type: none"> * Heat or cook food while in cans.
Sausage rolls, Pies, Christmas pudding	<ul style="list-style-type: none"> * These foods have high sugar and/or fat contents. * Cook for the recommended time. 	<ul style="list-style-type: none"> * Overcook as they may catch fire.
Meats	<ul style="list-style-type: none"> * Use a microwave proof roasting rack to collect drained juices. 	<ul style="list-style-type: none"> * Place meat directly on the turntable for cooking.
Utensils	<ul style="list-style-type: none"> * Check the utensils are suitable for MICROWAVE cooking before you use them. 	<ul style="list-style-type: none"> * Use metal utensils for MICROWAVE cooking. Metal reflects microwave energy and may cause an electrical discharge known as arcing.
Aluminium foil	<ul style="list-style-type: none"> * Use to shield food to prevent over cooking. * Watch for sparking. Reduce foil or keep clear of cavity walls. 	<ul style="list-style-type: none"> * Use too much. * Shield food close to cavity walls. Sparking can damage the cavity.
Browning dish	<ul style="list-style-type: none"> * Place a suitable insulator such as microwave and heat proof dinner plate between the turntable and the browning dish. 	<ul style="list-style-type: none"> * Exceed the preheating time recommended by the manufacturer. Excessive preheating can cause the glass turntable to shatter and/or damage internal parts of the oven.

INSTALLATION INSTRUCTIONS

1. Remove all packing materials from the oven cavity. Check the unit for any damage, such as a misaligned door, damaged door seals around the door or dents inside the oven cavity or on the door. If there is any damage, please do not operate the oven until it has been checked by a SERVICE CENTRE APPROVED BY SHARP and repaired, if necessary.
2. Accessories provided
 - 1) Turntable 2) Roller stay
 - 3) Operation manual and Cook book
3. Locate the roller stay in the centre of the oven, then fit the turntable on the roller stay. Make sure the turntable and roller stay are centrally located and locked together. Refer to OVEN DIAGRAM below. NEVER operate the oven without the roller stay and turntable.
4. The oven should not be installed in any area where excessive heat and steam are generated, for example, next to a conventional oven unit. The oven should be installed so as not to block ventilation openings. Allow at least 10cm on the top, 5cm on the both sides and at the rear of the oven for free air space.
5. Neither the manufacturer nor the distributors can accept any liability for damage to the machine or personal injury for failure to observe the correct electrical connecting procedure.
The A.C. voltage must be single phase 230 – 240V, 50Hz.
6. Operate the oven from a general purpose domestic outlet.
If a generator is used, do not operate the oven with non-sinusoidal outputs.

OVEN DIAGRAM

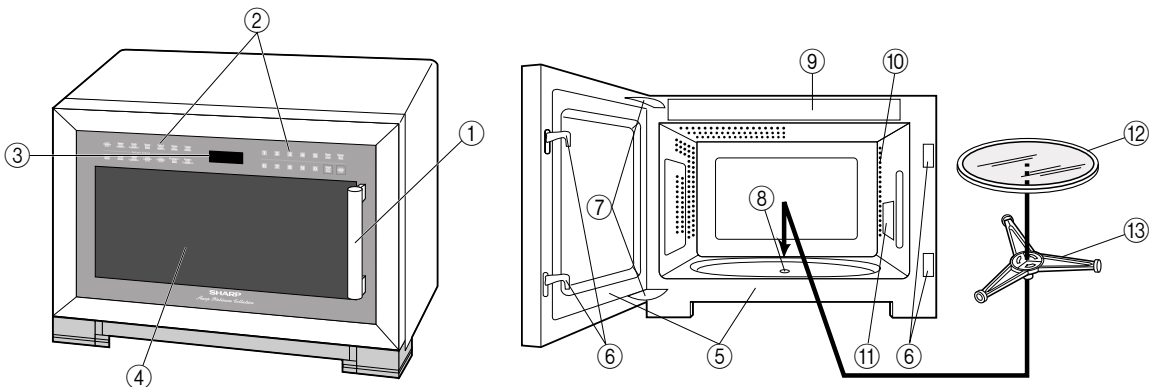

- ① Door handle
- ② Touch control panel
- ③ Digital readout
- ④ See through door
- ⑤ Door seals and sealing surfaces
- ⑥ Door safety latches
- ⑦ Door hinges
- ⑧ Coupling
- ⑨ Menu label
- ⑩ Oven lamp
- ⑪ Waveguide cover
- ⑫ Turntable
- ⑬ Roller stay
- ⑭ Ventilation openings
- ⑮ Power supply cord

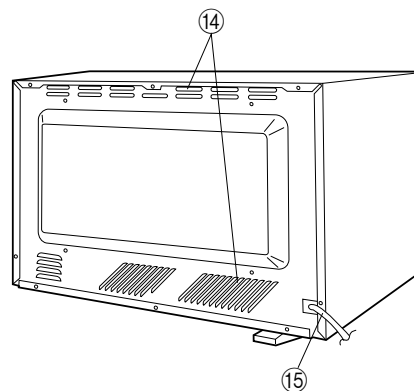

OPERATION OF TOUCH CONTROL PANEL

The operation of the oven is controlled by pressing the appropriate pads arranged on the surface of the control panel.

An entry signal tone should be heard each time you press the control panel to make a correct entry.

In addition the oven will beep for approximately 2 seconds at the end of the cooking cycle, or 4 times when a cooking procedure is required.

Control Panel Display



Touch Control Panel Layout

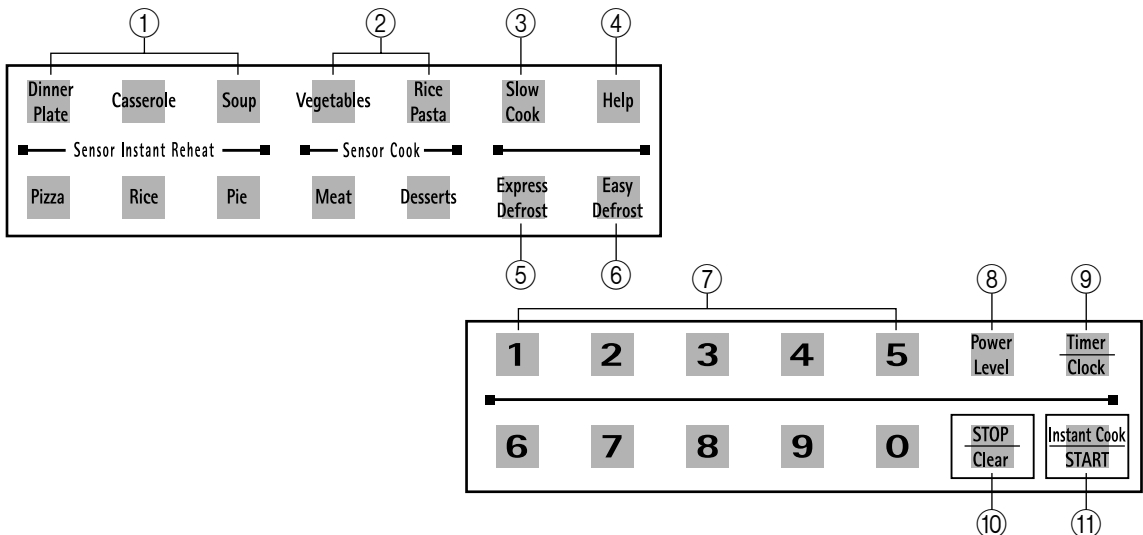

- ① **SENSOR INSTANT REHEAT PADS**
Press once to reheat 1 of 6 popular menus.
- ② **SENSOR COOK PADS**
Press to select Sensor Cook menus.
- ③ **SLOW COOK PAD**
Press to cook slowly and for a longer time.
- ④ **HELP PAD**
Press to select auto start, child lock, demonstration modes or info on pads.
Press to get cooking information.
- ⑤ **EXPRESS DEFROST PAD**
Press to select the Express Defrost menu.
- ⑥ **EASY DEFROST PAD**
Press to defrost frozen food by entering quantity.
- ⑦ **NUMBER PADS**
Press to enter cooking times, clock time, weight or quantity of food.
- ⑧ **POWER LEVEL PAD**
Press to select microwave power setting.
If not pressed, HIGH is automatically selected.
Press to alter the cooking result for automatic operations.
- ⑨ **TIMER/CLOCK PAD**
Press to set clock or timer.
- ⑩ **STOP/CLEAR PAD**
Press to clear during programming.
Press once to stop operation of oven during cooking; press twice to cancel cooking programme.
- ⑪ **INSTANT COOK/START PAD**
Press once to cook for 1 minute on HIGH or increase by 1 minute multiples each time this pad is pressed during cooking.
Press to start oven after setting programmes.



BEFORE OPERATING

* This oven is preset with the INFORMATION GUIDE.

To assist you in operating your oven useful information will appear on the display.



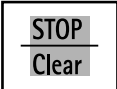

In this manual, the display of information guide is abbreviated.

Getting Started

Step	Procedure	Pad Order	Display
1	Plug the oven into a power point and switch on the power. Ensure the oven door is closed.		SHARP, MICRO-WAVE, OVEN will be displayed repeatedly.
2	Press the STOP/CLEAR pad so that the oven beeps.		 Only the dots will remain.

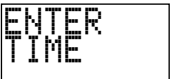
Clock Setting

* To enter the present time of day 11:34 (AM or PM).

Step	Procedure	Pad Order	Display
1	Press the TIMER/CLOCK pad twice.	 x 2	
2	Enter the correct time of day by pressing the numbers in sequence.		 The dots (:) will flash on and off.
3	Press the TIMER/CLOCK pad again.		

This is a 12 hour clock. If you attempt to enter an incorrect clock time (Ex. 13:45) ERROR will appear in the display. Press the STOP/CLEAR pad and re-enter the time of day (Ex. 1:45).

If you wish to know the time of day during the cooking, auto start or timer mode, press the TIMER/CLOCK pad. As long as your finger is pressing the TIMER/CLOCK pad, the time of day will be displayed.

Stop/Clear

Press the STOP/CLEAR pad once to:

1. Stop the oven temporarily during cooking.
2. Clear if you make a mistake during programming.
3. Clear the message on the display after cooking.

To Cancel a Programme During Cooking

Press the STOP/CLEAR pad twice.

MANUAL OPERATIONS

Microwave Time Cooking

This is a manual cooking feature, first enter the cooking time then the power level. There are five different power levels. You can programme up to 99 minutes, 99 seconds.

Power level	<table border="1"> <tr> <td>LOW</td> <td>M•LOW</td> <td>MEDIUM</td> <td>M•HIGH</td> <td>HIGH</td> </tr> <tr> <td>10%</td> <td>30%</td> <td>50%</td> <td>70%</td> <td>100%</td> </tr> </table>					LOW	M•LOW	MEDIUM	M•HIGH	HIGH	10%	30%	50%	70%	100%
LOW	M•LOW	MEDIUM	M•HIGH	HIGH											
10%	30%	50%	70%	100%											
Approximate percentage of microwave power															
Examples of foods typically cooked on different microwave power levels	Keeping food warm	Defrosting Softening butter	Casseroles Seafood	Cakes Muffins Slices	Fruit Vegetables Rice/Pasta										



This variable cooking control allows you to select the rate of microwave cooking. If a power level is not selected, then HIGH power is automatically used.

* Suppose you want to cook for 10 minutes on HIGH power.

Step	Procedure	Pad Order	Display
1	Enter desired cooking time.	1 0 0 0	1000
2	Press the INSTANT COOK/START pad.		1000 COOK The timer begins to count down.

To lower the power press the POWER LEVEL pad once. Note the display will indicate "HIGH". To lower to "M•HIGH" press the POWER LEVEL pad again. Repeat as necessary to select "MEDIUM", "M•LOW" or "LOW" power levels.

* Suppose you want to cook Fish Fillets for 10 minutes on MEDIUM power.







Step	Procedure	Pad Order	Display
1	Enter desired cooking time.	1 0 0 0	1000
2	Select power level by pressing the POWER LEVEL pad as required (for MEDIUM press three times).	 x 3	MEDIUM
3	Press the INSTANT COOK/START pad.		1000 COOK The timer begins to count down.

If the door is opened during the cooking process, the cooking time in the display automatically stops. The cooking time starts to count down again when the door is closed and the INSTANT COOK/START pad is pressed. If you want to check the power level during the cooking, press POWER LEVEL pad. As long as your finger is pressing the POWER LEVEL pad, the power level will be displayed.

Sequence Cooking



Your oven can be programmed up to 3 automatic cooking sequences, automatically switching from one variable power setting to the next.

* Suppose you want to cook for 10 minutes on MEDIUM followed by 5 minutes on HIGH.

Step	Procedure	Pad Order	Display
1	Enter desired cooking time.	1 0 0 0	
2	Select desired power level by pressing the POWER LEVEL pad (for MEDIUM press three times).	Power Level x 3	
3	For second sequence, enter desired time for cooking time. If power is not selected the oven will operate at HIGH power.	5 0 0	
4	Press the INSTANT COOK/START pad.		 The timer begins to count down to zero. When it reaches zero,  the second sequence will appear and the timer will begin counting down to zero again.

Instant Cook™

For your convenience Sharp's Instant Cook allows you to easily cook for one minute on HIGH power.

Step	Procedure	Pad Order	Display
1	Press the INSTANT COOK/START pad. Within 3 minutes of closing the door.		 The timer begins to count down.

Press the INSTANT COOK/START pad until desired time is displayed.
Each time the pad is pressed, the cooking time is increased by 1 minute.

Increasing Time During a Cooking Programme

Microwave time can be added during a cooking programme using the INSTANT COOK/START pad.



* Suppose you want to increase cooking time by 2 minutes during 5 minutes on MEDIUM cooking.

Step	Procedure	Pad Order	Display
1	Enter desired cooking time.	5 0 0	500
2	Select power level by pressing the POWER LEVEL pad as required. (for MEDIUM press three times)	Power Level x3	MEDIUM
3	Press the INSTANT COOK/START pad.	Instant Cook START	500 COOK The timer starts to count down. 130 COOK
4	Press the INSTANT COOK/START pad twice to increase time by two minutes.	Instant Cook START x2	330 COOK

Slow Cook

Slow Cook The SLOW COOK setting is designed for food which require longer cooking time. For example, stewing, braising. The maximum cooking time that can be programmed is 2 hours.

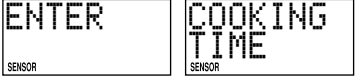
* To cook on SLOW COOK for 1 hour 30 minutes.

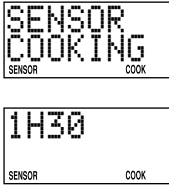
Step	Procedure	Pad Order	Display
1	Press the SLOW COOK pad.	Slow Cook	
2	Enter desired cooking time.	1 3 0	
3	Press the INSTANT COOK/START pad. * When the sensor detects the vapour from the food, the programmed cooking time will appear.		 <p>The cooking time will begin counting down.</p>

- NOTE**
- After oven is plugged in, wait 2 minutes before using SLOW COOK.
 - ERROR will be displayed if :
 - the oven door is opened or the STOP/CLEAR pad is pressed before the cooking time is displayed.
To clear, press the STOP/CLEAR pad and cook manually using MEDIUM setting. Check the food several times during cooking.
 - more than the maximum cooking time is programmed when the INSTANT COOK/START pad is pressed.
To clear, press the STOP/CLEAR pad and reprogramme.
 - If you need to check the cooking result while the timer is counting down, you can open the oven door by pressing the STOP/CLEAR pad once, then check and stir. After that close the door and press the INSTANT COOK/START pad to resume cooking.

SPECIAL NOTES ON SLOW COOKING

For better cooking result, always try to:

- Cut the ingredients into smaller pieces.
- Add in adequate liquid medium (eg: water, sauce) and try to submerge the ingredients into the liquid medium in order to avoid scorching. This is especially important when stewing or making soup.
- Do not add too much seasonings or salt at the initial stage of cooking. Try to add (especially salt) midway through the cooking cycle.
- Cook with the casserole lid on.
- Stir and stand for 10 minutes after cooking.

AUTOMATIC OPERATIONS

Notes for Automatic Operations

- Wipe off any moisture from the outside of cooking containers and the interior of the oven with a dry cloth or paper towel prior to cooking on SENSOR INSTANT REHEAT or SENSOR COOK.
- After oven is plugged in, wait 2 minutes before using SENSOR INSTANT REHEAT or SENSOR COOK.
- ERROR will be displayed if:
 - more or less than the quantity or weight of foods suggested in the EASY DEFROST MENU GUIDE is programmed when the INSTANT COOK/START pad is pressed.
To clear, press the STOP/CLEAR pad and reprogramme.
 - the door is opened or the STOP/CLEAR pad is pressed before the cooking time is displayed.
To clear, press the STOP/CLEAR pad and cook manually.
- When using the automatic features (SENSOR INSTANT REHEAT, SENSOR COOK, EXPRESS DEFROST, EASY DEFROST), carefully follow the details provided in each MENU GUIDE to achieve the best result.
If the details are not followed carefully, the food may be overcooked or undercooked or ERROR may be displayed.
- When cooking small quantities of food on SENSOR INSTANT REHEAT or SENSOR COOK, the food may be cooked without displaying any remaining cooking time or requiring any operations during the cooking.
- To defrost foods above or below the weights allowed on the EXPRESS DEFROST MENU GUIDE, use EASY DEFROST or defrost manually.
- Food weighing more or less than the quantity or weight listed in each MENU GUIDE, cook manually.
- When entering the weight of the food, round off the weight to the nearest 0.1kg(100g). For example, 1.65kg would become 1.7kg.
- To change the final cooking or defrosting result from the standard setting, press the POWER LEVEL pad once (for more) or twice (for less) after selecting desired setting. See page 18.
- The final cooking result will vary according to the food condition (e.g. initial temperature, shape, quality). Check the food after cooking and if necessary continue cooking manually.

Sensor Instant Reheat

Dinner Plate Casserole Soup
Pizza Rice Pie

Sensor Instant Reheat

Press once to reheat 6 popular menus.
Follow the details provided in SENSOR INSTANT REHEAT MENU GUIDE on page ③, ④ in the cooking guides.

* Suppose you want to reheat 4 cups of soup.

Step	Procedure	Pad Order	Display
1	Press the SENSOR INSTANT REHEAT pad for soup (within 3 minutes of closing the door). *When the sensor detects the vapour from the food, the remaining reheating time will appear. (eg. remaining reheating time is approximately 1 min. 30 sec.)		<p>After about 2 sec., the oven will start automatically.</p> <p>The timer begins to count down. When the cooking time reaches zero, STIR, ENJOY YOUR, SOUP will be displayed.</p>

Sensor Cook

Vegetables

Rice
Pasta

— Sensor Cook —

Meat

Desserts

VEGETABLES

1. Fresh-Hard
2. Fresh-Soft
3. Frozen
4. Jacket Potato
5. Fresh Soup

RICE/PASTA

1. White Rice
2. Dry Pasta
3. Fresh Pasta
4. Instant Noodles
5. Frozen Pasta
6. Porridge

MEAT







1. Roast Beef
2. Roast Lamb
3. Roast Chicken
4. Corned Meat
5. Casserole
6. Seasoned Roast
7. Fish Fillets

DESSERTS

1. Cake
2. Stewed Fruit
3. Pudding
4. Crunch
5. Muesli Delight

SENSOR COOK will automatically compute the power level and cooking time. SENSOR COOK has 4 categories. To select a menu, press the desired SENSOR COOK pad until the menu of your choice is displayed. Follow the details provided in SENSOR COOK MENU GUIDE or SENSOR COOK RECIPES on page ⑤ - ⑬ in the cooking guides.

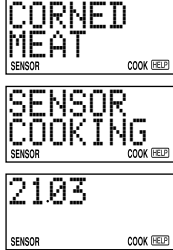
* Suppose you want to use Sensor Cook to cook 0.5 kg of Corned Meat.

Step	Procedure	Pad Order	Display
1	Select menu category and menu number for SENSOR COOK. Press MEAT pad 4 times to cook Corned Meat.	 x 4	
	If you require a cooking hint, press the HELP pad.		
2	Press the INSTANT COOK/START pad. * When the sensor detects the vapour from the food, the remaining cooking time will appear. (eg. remaining cooking time is approximately 21 min. 03 sec.)		 The cooking time will begin counting down. The oven will "beep" 4 times and will stop. TURN CORNED, MEAT OVER will be displayed repeatedly.
3	Open the door. Turn over meat. Close the door.		PRESS START will be displayed repeatedly.
4	Press the INSTANT COOK/START pad.		 The cooking time will begin counting to zero, when it reaches zero, the oven will "beep". STAND COVERED, 5-10 MIN FOIL, ENJOY YOUR, CORNED MEAT will be displayed repeatedly.

You can get a cooking hint whenever HELP is lit in the display. See page 18.





Express Defrost

**Express
Defrost**

1. Fish Fillets
2. Chicken Fillets
3. Sausages /
Minced Meat

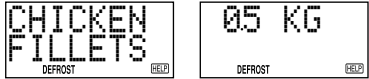
EXPRESS DEFROST rapidly defrosts 0.5 kg specific foods. Follow the details provided in EXPRESS DEFROST MENU GUIDE on page 14 in the cooking guides.

* Suppose you want to defrost 0.5 kg of Chicken Fillets.

Step	Procedure	Pad Order	Display
1	Press the EXPRESS DEFROST pad until the desired menu is displayed (for Chicken Fillets press twice).	Express Defrost x 2	
	If you require a cooking hint, press the HELP pad.	Help	
2	Press the INSTANT COOK/START pad.	Instant Cook START	 The cooking time will begin counting down. The oven will "beep" 4 times and will stop. TURN CHICKEN, OVER, SEPARATE INTO, PIECES will be displayed repeatedly.
3	Open the door. Turn meat over and separate into pieces. Close the door.		PRESS START will be displayed repeatedly.
4	Press the INSTANT COOK/START pad.	Instant Cook START	 The cooking time will begin counting to zero. When it reaches zero, the oven will "beep". STAND COVERED, 5 MIN FOIL will be displayed repeatedly.









You can get a cooking hint whenever HELP is lit in the display. See page 18.

Easy Defrost

Easy Defrost

The Easy Defrost feature allows you to defrost meats by entering weight. Follow the details provided in EASY DEFROST MENU GUIDE on page 15 in the cooking guides.

* Suppose you want to defrost 2.0 kg of Poultry.

Step	Procedure	Pad Order	Display
1	Select menu number for EASY DEFROST. Press EASY DEFROST pad 4 times to defrost Poultry.	 x 4	
2	Press number pads to enter weight.		
3	Press the INSTANT COOK/START pad.		 The cooking time will begin counting down. The oven will “beep” 4 times and will stop. TURN, POULTRY OVER, SHIELD WARM, PORTION will be displayed repeatedly.
4	Open the door. Turn over meat. Close the door.		PRESS START will be displayed repeatedly.
5	Press the INSTANT COOK/START pad.		 The cooking time will begin counting to zero, when it reaches zero, the oven will “beep”. STAND COVERED, 5-50 MIN FOIL will be displayed repeatedly.

You can get a cooking hint whenever HELP is lit in the display. See page 18.

OTHER CONVENIENT FEATURES

Help Feature

Help The HELP feature has 5 different programmes.

Auto Start

The Auto Start feature allows you to set your oven to start automatically.

* Suppose you want to start cooking a casserole for 20 minutes on MEDIUM at 4:30 in the afternoon.
(Check that the correct time of day is displayed.)

Step	Procedure	Pad Order	Display
1	Press the HELP pad.	Help	<div style="display: flex; flex-wrap: wrap;"> <div style="border: 1px solid black; padding: 2px; margin: 2px;">AUTO START</div> <div style="border: 1px solid black; padding: 2px; margin: 2px;">PRESS 1</div> <div style="border: 1px solid black; padding: 2px; margin: 2px;">LOCK PRESS 2</div> <div style="border: 1px solid black; padding: 2px; margin: 2px;">DEMO PRESS 3</div> <div style="border: 1px solid black; padding: 2px; margin: 2px;">INFO ON PADS</div> <div style="border: 1px solid black; padding: 2px; margin: 2px;">PRESS</div> <div style="border: 1px solid black; padding: 2px; margin: 2px;">DESIRED PAD</div> </div>
2	Press the number 1 pad.	1	<div style="display: flex; flex-wrap: wrap;"> <div style="border: 1px solid black; padding: 2px; margin: 2px;">AUTO START</div> <div style="border: 1px solid black; padding: 2px; margin: 2px;">ENTER</div> <div style="border: 1px solid black; padding: 2px; margin: 2px;">START TIME</div> </div>
3	Enter the desired start time.	4 3 0	<div style="border: 1px solid black; padding: 5px; text-align: center;">4:30</div> <p>The dots (:) will flash on and off.</p>
4	Press the TIMER/CLOCK pad.	Timer Clock	<div style="border: 1px solid black; padding: 5px; text-align: center;">4:30</div>
5	Enter the desired cooking time.	2 0 0 0	<div style="border: 1px solid black; padding: 5px; text-align: center;">2000</div>
6	Select power level by pressing the POWER LEVEL pad as required. (for MEDIUM press three times)	Power Level x 3	<div style="border: 1px solid black; padding: 5px; text-align: center;">MEDIUM</div>
7	Press the INSTANT COOK/START pad.	Instant Cook START	<div style="border: 1px solid black; padding: 5px; text-align: center;">AUTO START</div> <div style="border: 1px solid black; padding: 5px; text-align: center;">4:30 ON</div> <p>The oven will start cooking at 4:30 P.M.</p> <div style="border: 1px solid black; padding: 5px; text-align: center;">2000</div> <p style="text-align: right; font-size: small;">COOK</p> <p>The timer begins to count down. When the timer reaches zero, all indicators will go off and the oven will "beep". END will appear in the display.</p>

To check the current time, simply press the TIMER/CLOCK pad, the time will be displayed.

If the door is opened after step 7, close the door and press the START pad to continue with Auto Start.
Press the STOP/CLEAR pad to cancel Auto Start.





The correct time of day must be set before using Auto Start, see clock setting on page 6.

Child Lock

If the oven is accidentally started with no food or liquid in the cavity, the life of the oven can be reduced. To prevent accidents like this, your oven has a "Child Lock" feature that you can set when the oven is not in use.

* To set the Child Lock.

After step 1 for Auto Start.

Step	Procedure	Pad Order	Display
2	Press the number 2 pad.		
3	Press the INSTANT COOK/START pad.		 The time of day will appear in the display.

The control panel is now locked, each time a pad is pressed, the display will show "LOCK".

* To unlock the control panel.

After step 2 for Child Lock.

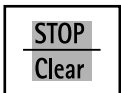
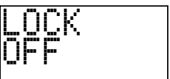

Step	Procedure	Pad Order	Display
3	Press the STOP/CLEAR pad.		 The time of day will appear in the display. The oven is ready to use.

Demonstration Mode

This feature is mainly for use by retail outlets, and also allows you to practice key operations.

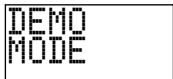

* To demonstrate.

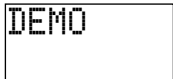
After step 1 for Auto start.

Step	Procedure	Pad Order	Display
2	Press the number 3 pad.		
3	Press the INSTANT COOK/START pad.		 Then DEMO, SHARP, MICROWAVE, OVEN will appear repeatedly.

Cooking operations can now be demonstrated with no power in the oven.

* Suppose you demonstrate Instant Cook.

Step	Procedure	Pad Order	Display
1	Press the INSTANT COOK/START pad.		 The cooking time will begin counting down to zero at ten times the speed. When the timer reaches zero, END will appear in the display.

* To cancel the Demonstration Mode.

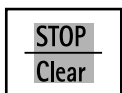
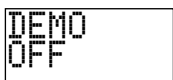

After step 2 above.

Step	Procedure	Pad Order	Display
3	Press the STOP/CLEAR pad.		 The time of day will appear in the display.

Info on Pads

Each pad has a useful guide.

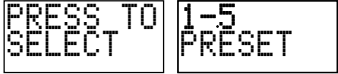
* To get the guide for VEGETABLES pad. After step 1 for Auto Start.

Step	Procedure	Pad Order	Display
2	Press the VEGETABLES pad.		 

The guide message will be repeated twice, and then the display will show the time of day. If you want to cancel the guide, press the STOP/CLEAR pad.

Help

The SENSOR COOK, EXPRESS DEFROST and EASY DEFROST menus have cooking hints. If you wish to check, press the HELP pad whenever HELP is lit in the display.

Less/More Setting

The cooking times programmed into the automatic menus are tailored to the most popular tastes. To adjust the cooking time to your individual preference use the “more” or “less” feature to either add (more) or reduce (less) cooking time.

The LESS/MORE can be used to adjust the cooking time of the following features

- SENSOR INSTANT REHEAT
- SENSOR COOK
- EXPRESS DEFROST
- EASY DEFROST

Press the POWER LEVEL pad once (for more) or twice (for less) after selecting desired setting.

(1) SENSOR INSTANT REHEAT

* Suppose you want to reheat 4 serves soup for less time than the standard setting.

Step	Procedure	Pad Order	Display
1	Press the SENSOR INSTANT REHEAT pad for soup.	Soup	SOUP SENSOR
2	Press the POWER LEVEL pad twice within 2 seconds after step 1.	Power Level x 2	LESS SENSOR After about 2 sec., the oven will start automatically.

(2) EASY DEFROST

* Suppose you want to defrost 2.0 kg Poultry for longer than the standard setting.

Step	Procedure	Pad Order	Display
1	Select menu number for EASY DEFROST. Press EASY DEFROST pad 4 times to defrost Poultry.	Easy Defrost x 4	POULTRY DEFROST HELP
2	Press number pads to enter weight.	2 0	20 KG DEFROST HELP
3	Press the POWER LEVEL pad once.	Power Level x 1	20 KG MORE DEFROST HELP
4	Press the INSTANT COOK/START pad.	Instant Cook START	3746 DEFROST DEFROST COOK HELP

For EXPRESS DEFROST, SENSOR COOK select the menu using the EXPRESS DEFROST pad or desired SENSOR COOK pad instead of the EASY DEFROST pad, and go to step 3.





Timer

Use this feature as a general purpose timer. Examples include:

- timing boiled eggs cooked on the stove top.
- timing the recommended standing time of food.

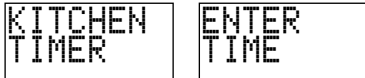
You can enter any time up to 99 minutes, 99 seconds. If you want to cancel the timer during the count down phase simply press STOP/CLEAR and the display will return to showing time of day.

* Suppose you want to set the timer to 3 minutes for boiling an egg on the stove top:

Step	Procedure	Pad Order	Display
1	Press the TIMER/CLOCK pad once.		
2	Enter desired time.		
Once the egg has come to the boil in the saucepan you can start the timer			
3	Press the TIMER/CLOCK pad.		 The timer begins to count down. When the timer reaches zero, the oven will "beep". END will appear in the display.

Alarm

Your oven has an alarm function. If you leave food in the oven after cooking, the oven will "beep" 3 times and REMOVE FOOD will be appeared in the display after 2 minutes.

If you do not remove the food at that time, the oven will "beep" 3 times after 4 minutes and 6 minutes.

CARE AND CLEANING

CLEAN THE OVEN AT REGULAR INTERVALS

Disconnect the power supply cord before cleaning. And if possible leave the door open to inactivate the oven.

Exterior:

The outside may be cleaned with mild soap and warm water, wipe clean with a damp cloth. Avoid the use of harsh abrasive cleaners.

Door/Touch Control Panel:

Care should be taken in cleaning the door/touch control panel. Wipe the door and window on both sides, the door seals and adjacent parts frequently with a damp cloth to remove any spills or spatters. Wipe the front side of the door (including the touch control panel) with a cloth dampened slightly with water only.

Do not scrub or use any sort of chemical cleaners. Do not use abrasive cleaner. Avoid the use of excess water.

Interior walls:

To clean the interior surfaces, wipe with a soft cloth and warm water for hygienic reasons. After use wipe the waveguide cover in the oven with a soft damp cloth to remove any food splashes. Built-up splashes may overheat and begin to smoke or catch fire. Do not remove the waveguide cover. **DO NOT USE A COMMERCIAL OVEN CLEANER, ABRASIVE OR HARSH CLEANERS AND SCOURING PADS ON ANY PART OF YOUR MICROWAVE OVEN. NEVER SPRAY OVEN CLEANERS DIRECTLY ONTO ANY PART OF YOUR OVEN.**

Avoid using excess water. After cleaning the oven, ensure any water is removed with a soft cloth.

Turntable/Roller Stay:

Wash with mild soapy water and dry thoroughly.

SERVICE CALL CHECK

Please check the following before calling for service:

1. Does the display light? YES _____ NO _____
2. When the door is opened, does the oven lamp come on? YES _____ NO _____
3. Place one cup of water (approx. 250 ml) in a glass measure in the oven and close the door securely. Oven lamp should go off if door is closed properly. Press the INSTANT COOK/START pad once.
 - A. Does the oven lamp light? YES _____ NO _____
 - B. Does the cooling fan work? YES _____ NO _____
(Put your hand over the rear ventilation openings.)
 - C. Does the turntable rotate? YES _____ NO _____
(The turntable can rotate clockwise or anticlockwise. This is quite normal.)
 - D. After one minute, did an audible signal sound and COOK indicator go off? YES _____ NO _____
 - E. Is the water inside the oven hot? YES _____ NO _____

If "NO" is the answer to any of the above questions, please check your wall socket and the fuse in your meter box.

If both the wall socket and the fuse are functioning properly, CONTACT YOUR NEAREST SERVICE CENTRE APPROVED BY SHARP.

- NOTE:
1. If time in the display is counting down rapidly, check Demonstration Mode. (See P16. for detail.)
 2. If you cook the food over 40 minutes on HIGH, the microwave power will be automatically reduced to avoid overheating.

SPECIFICATIONS



AC Line Voltage	Single phase 230-240V,50Hz
AC Power Required	1.55kW
Output Power	1000W*(IEC test procedure)
Microwave Frequency	2450 MHz **(Class B / Group 2)
Outside Dimensions (W x H x D)	495mm x 355mm x 525mm
Cavity Dimensions (W x H x D)	450mm x 222mm x 432mm
Oven Capacity	43 litre
Cooking Uniformity	Turntable (ø406mm tray) system
Weight	Approx. 22kg

* When tested in accordance with AS/NZS 2895.1.1995.

** This is the classification of ISM (Industrial, Scientific and Medical) equipment described in the International Standard CISPR11.

COOKING GUIDES



CONTENTS COOKING GUIDE

HELPFUL HINTS ①	COOKWARE AND UTENSIL GUIDE ②	SENSOR INSTANT REHEAT MENU GUIDE ③ - ④	SENSOR COOK MENU GUIDE ⑤ - ⑬	EXPRESS DE- FROST MENU GUIDE ⑭	EASY DEFROST MENU GUIDE ⑮	RECIPES ⑯ - ⑳
--------------------	------------------------------------	--	------------------------------------	--------------------------------------	------------------------------	------------------

HELPFUL HINTS

1. THE ARRANGEMENT

Arrange foods carefully. Place thickest areas toward outside of dish.



3. COVERING

Cover foods in the microwave if you would normally cover the food in your ordinary oven, or to retain moisture. Cover foods such as Vegetables, Casseroles, or when Reheating.

Use to cover foods:



LID



PLASTIC WRAP

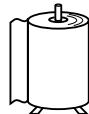

PAPER TOWEL

5. SHIELDING

Shield using small pieces of aluminium foil to shield thin areas of meat, fish and poultry or edges of cakes to prevent overcooking.



FISH



CHICKEN

7. STIRRING

Stir foods from the outside to the centre of the dish, once or twice during cooking if possible.

Eg. Casseroles and Sauces.



9. DENSITY

The depth to which microwaves penetrate food varies depending on the food's density. Porous foods like minced beef or mashed potatoes microwave faster than dense ones like steak or whole potatoes.

11. STARTING TEMPERATURE

Frozen or refrigerated foods take longer to heat than food at room temperature. Cooking times in this book are based on normal storage temperatures. Since rooms, refrigerators and freezers differ in temperature, check cooking result at the minimum time.



13. CONDENSATION

Condensation is a normal part of microwave cooking. The humidity and moisture in food will influence the amount of condensation in the oven. Generally, covered foods will not cause as much condensation as uncovered foods. Ensure that the ventilation openings are not blocked.

2. TURNING

Foods such as poultry and joints of meat should be turned over after half the cooking time.

4. PIERCING

Pierce potatoes, eggs, tomatoes or any foods with a skin or membrane to allow steam to escape.



TOMATO



EGG

6. STANDING TIME

Standing time is important. After cooking or defrosting ensure adequate standing time. This allows the food to continue cooking or heating. Refer to cooking guides for each menu or according to manufacturers instructions.

8. SIZE

Small pieces cook faster than large ones. To speed up cooking, cut pieces smaller than 5 cm so microwaves can penetrate to the centre from all sides. For even cooking, make all the pieces the same size.







10. FAT AND BONE

Marbling within meat, or a thin, even layer of fat on a roast, speeds cooking. Large fatty areas or excess drippings in dish attract energy away from meat, and slows cooking. Centre bones do not affect cooking, but bone on the side of meat conducts heat to the areas next to it.

12. QUANTITY

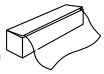
Microwave cooking times are directly related to the amount of food in the oven. Because energy is absorbed by the food itself, one potato or a single piece of chicken cooks rapidly. When the energy is divided among several items, cooking takes more time.

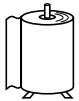
COOKWARE AND UTENSIL GUIDE

Utensil	Use	Advice
GLASSWARE/CERAMIC (HEAT RESISTANT) 	YES	GLASSWARE <ul style="list-style-type: none"> • Ordinary glass is not suitable for cooking but may be used for short periods for heating foods. CERAMIC <ul style="list-style-type: none"> • Most ovenproof china, and ceramics, are suited. • Avoid dishes that are decorated with gold or silver leaf. • Avoid using antique pottery. • If unsure, check with the manufacturer.
METAL COOKWARE 	NO	<ul style="list-style-type: none"> • Metal cookware should be avoided when cooking in the microwave oven. • Microwave energy is reflected by metal.
PLASTIC WRAP/ OVEN BAGS (MICROWAVE SAFE ONLY) 	YES	<ul style="list-style-type: none"> • Plastic wrap can be used to cover food. • Some shrinkage of the wrap may occur, over an extended cooking time. • When removing wrap, lift it in such a way to avoid steam burns. • Do not tie oven bags with metal twist ties, substitute with string. • For cooking food with high fat content, do not bring the wrap in contact with the food as it may melt.
ALUMINIUM FOIL 	FOR SHIELDING	<ul style="list-style-type: none"> • Small amounts may be used to shield certain parts of meat and fish when cooking or defrosting. • Remove food in foil trays, if possible, and place in a microwave safe dish. • If not possible, place the foil tray onto a heat proof plate allowing 2.5 cm room between the walls of the oven.
STRAW AND WOOD 	NO	<ul style="list-style-type: none"> • Excessive over heating of these materials may cause a fire in the microwave oven.
PAPER 	YES	<ul style="list-style-type: none"> • Paper towels and waxed paper are suitable to use to prevent splatters. • These are suitable for use when reheating foods or for short cooking times.
PLASTIC COOKWARE MICROWAVE SAFE 	YES	<ul style="list-style-type: none"> • Ideal for cooking, reheating and defrosting. • Some microwave safe plastic cookware are not suitable for cooking foods with high fat and sugar content.
BROWNING DISH 	YES	<ul style="list-style-type: none"> • Ensure that the preheating time of the dish is not exceeded. • Ensure that a microwave heat proof dinner plate or suitable insulator be placed between the turntable and the browning dish.
THERMOMETERS • MICROWAVE SAFE • CONVENTIONAL	YES NO	

SENSOR INSTANT REHEAT MENU GUIDE

Dinner Plate Casserole Soup



— Sensor Instant Reheat —

Pizza Rice Pie

The final cooking result will vary according to the food condition (e.g. initial temperature, shape, quality).
Check the food after cooking and if necessary continue cooking manually.

Menu	Weight Range	Initial Temperature (approx.)	Procedure	Standing Time (minutes)									
Dinner Plate	1 serve (approx. 400 g)	+ 3°C Refrigerated	<ul style="list-style-type: none"> Cover with plastic wrap. After cooking, stand covered. 	2									
	<table border="1"> <thead> <tr> <th>MEAT</th> <th>POTATO</th> <th>VEGETABLES</th> </tr> </thead> <tbody> <tr> <td>175-180g</td> <td>125g</td> <td>100g</td> </tr> <tr> <td>Beef, Lamb Chicken, T-Bone</td> <td>sliced</td> <td>2 varieties eg. sliced Carrot, Zucchini Broccoli</td> </tr> </tbody> </table>	MEAT			POTATO	VEGETABLES	175-180g	125g	100g	Beef, Lamb Chicken, T-Bone	sliced	2 varieties eg. sliced Carrot, Zucchini Broccoli	
	MEAT	POTATO			VEGETABLES								
175-180g	125g	100g											
Beef, Lamb Chicken, T-Bone	sliced	2 varieties eg. sliced Carrot, Zucchini Broccoli											
Casserole Beef Stroganoff Springtime Lamb Apricot Chicken Canned Food Baked Beans Spaghetti	1 – 4 cups (1 cup, 250 ml)	+ 3°C Refrigerated	<ul style="list-style-type: none"> Place into a casserole dish, and cover with lid. After cooking, stir and stand covered. 	1-5									
		+ 20°C Room temperature											
Soup	1 – 4 cups (1 cup, 250 ml)	+ 20°C Room temperature	<ul style="list-style-type: none"> Place in a Pyrex® bowl. Cover with glass lid or plastic wrap. After cooking, stir. <p>HINT For other beverages, see HINT on page ④.</p>										
Pizza	1 – 4 pieces (1 piece, approx. 90 g)	+ 3°C Refrigerated	<ul style="list-style-type: none"> Place pizza on paper towel on the turntable. 										
Rice includes : White rice Brown rice Fried rice	1 – 4 cups (1 cup, 250 ml)	+ 3°C Refrigerated	<ul style="list-style-type: none"> Place into a casserole dish, and cover with lid. After cooking, stir. 										

SENSOR INSTANT REHEAT MENU GUIDE

Menu	 Weight Range	 Initial Temperature (approx.)	Procedure	 Standing Time (minutes)
Pie includes: Pies Pasties	1 – 4 pieces (1 piece, approx. 160-200 g)	+ 3°C Refrigerated	<ul style="list-style-type: none"> • Place pie upside down on the turntable. • Cover with paper towel. • When oven stops and TURN PIES OVER is displayed, turn pies over and continue cooking covered. • After cooking, stand. 	1-3

HINT

To Reheat Beverage

Tea, Coffee, Water(+20°C Room Temperature)

Qty(250 ml per 1 cup)	Cooking Time	Power Level
1 cup	1 min. 30 sec.	HIGH
2 cups	3 min.	HIGH



*Stir after heating.

SENSOR COOK MENU GUIDE



VEGETABLES MENU GUIDE

Vegetables

When you cook the following menus with SENSOR COOK, press the VEGETABLES pad until the desired menu appears in the display.

No.	Menu	 Weight Range	 Initial Temperature (approx.)	Procedure	 Standing Time (minutes)
1	Fresh Vegetables Hard Carrots Potato Beans Broccoli Cauliflower Pumpkin	0.1-1.0 kg	+ 3°C Refrigerated	<ul style="list-style-type: none"> Wash the vegetables. Arrange the vegetables in a shallow dish. Cover with a glass lid or plastic wrap. After cooking, stir then stand covered. 	1-5
2	Fresh Vegetables Soft Brussels Sprouts Zucchini Spinach Cabbage Squash	0.1-1.0 kg	+ 3°C Refrigerated	<ul style="list-style-type: none"> Wash the vegetables. Pierce skin of squash with fork. Arrange the vegetables in a shallow dish. Cover with a glass lid or plastic wrap. After cooking, stir then stand covered. 	1-5
3	Frozen Vegetables Carrots } hard vegetables Beans } Brussels Sprouts } Broccoli } medium vegetables Cauliflower } Corn } Green Peas } soft vegetables Mixed Vegetables }	0.1-1.0 kg	-18°C Frozen	<ul style="list-style-type: none"> Before cooking, separate vegetables eg. broccoli as much as possible. Arrange the vegetables in a shallow dish in the following way : hard vegetables around the outside, soft vegetables in the centre, medium vegetables in-between. Cover with a glass lid or plastic wrap. After cooking, stir then stand covered. 	1-5
4	Jacket Potato Potato (whole)	(1-10 pieces 1 piece, approx. 150 g)	+ 20°C Room temperature	<ul style="list-style-type: none"> Use washed new potatoes. Pierce twice with fork on each side. Place on outside of turntable. When oven stops and TURN POTATO, OVER is displayed, turn potatoes over and continue cooking. After cooking, stand covered with aluminium foil. <p>N.B. For small quantities, the food may not require a turn over during the cooking.</p>	3-10



VEGETABLES MENU GUIDE

No.	Menu	 Weight Range		 Initial Temperature (approx.)	Procedure	 Standing Time (minutes)											
5	Fresh Soup <i>Pumpkin Soup</i>	2-12 serves		+ 20°C Room temperature	<ul style="list-style-type: none"> Combine all ingredients except cream and nutmeg in a casserole dish and cover with plastic wrap or glass lid. When oven stops and STIR is displayed, stir soup. Continue cooking covered. The oven will stop again and display STIR. Stir soup and continue cooking covered. After cooking, stir and place in a blender or processor and blend until smooth. Transfer to a serving bowl and stir in cream and nutmeg. Season to taste. 												
	<table border="1"> <thead> <tr> <th data-bbox="170 344 566 378">Serves</th> <th data-bbox="566 344 697 378">2-4 serves</th> <th data-bbox="697 344 832 378">4-6 serves</th> <th data-bbox="832 344 967 378">6-8 serves</th> <th data-bbox="967 344 1089 378">8-12 serves</th> </tr> </thead> <tbody> <tr> <td data-bbox="170 378 566 495"> Ingredients; pumpkin small onion chicken stock cream nutmeg, salt, pepper </td> <td data-bbox="566 378 697 495"> 500 g 1 1/2 cup 1/2 cup to taste </td> <td data-bbox="697 378 832 495"> 1000 g 2 1 cup 1 cup to taste </td> <td data-bbox="832 378 967 495"> 1500 g 3 1 1/2 cups 1 1/2 cups to taste </td> <td data-bbox="967 378 1089 495"> 2000 g 4 2 cups 2 cups to taste </td> </tr> </tbody> </table>	Serves	2-4 serves	4-6 serves			6-8 serves	8-12 serves	Ingredients; pumpkin small onion chicken stock cream nutmeg, salt, pepper	500 g 1 1/2 cup 1/2 cup to taste	1000 g 2 1 cup 1 cup to taste	1500 g 3 1 1/2 cups 1 1/2 cups to taste	2000 g 4 2 cups 2 cups to taste				
	Serves	2-4 serves	4-6 serves	6-8 serves			8-12 serves										
Ingredients; pumpkin small onion chicken stock cream nutmeg, salt, pepper	500 g 1 1/2 cup 1/2 cup to taste	1000 g 2 1 cup 1 cup to taste	1500 g 3 1 1/2 cups 1 1/2 cups to taste	2000 g 4 2 cups 2 cups to taste													
<i>Potato and Leek Soup</i>					<ul style="list-style-type: none"> Combine butter, leeks, potatoes and stock in a casserole dish. Cover with plastic wrap or a lid. When oven stops and STIR is displayed, stir soup. Continue cooking covered. The oven will stop again and display STIR. Stir soup and continue cooking covered. After cooking, stir and place in a blender or processor and blend until smooth. Transfer to a serving bowl and stir in worcestershire sauce and cream. Season to taste. 												



RICE / PASTA / CEREAL MENU GUIDE

Rice Pasta

When you cook the following menus with SENSOR COOK, press the RICE/PASTA pad until the desired menu appears in the display.

No.	Menu	 Weight Range	 Initial Temperature (approx.)	Procedure	 Standing Time (minutes)														
1	White Rice	1/2 - 4 cups	+60°C hot tap water or soup stock	<ul style="list-style-type: none"> Wash rice thoroughly until water runs clear. Place into a Pyrex® bowl and cover with hot tap water or soup stock. Cook uncovered. When oven stops and STIR is displayed, stir and continue cooking. After cooking stand and stir. 	3-5														
	<table border="1"> <tr> <td>Rice</td> <td>1/2 cup</td> <td>1 cup</td> <td>1 1/2 cups</td> <td>2 cups</td> <td>3 cups</td> <td>4 cups</td> </tr> <tr> <td>Hot tap water or soup stock (1 cup=250ml)</td> <td>1 1/2 cups</td> <td>2 cups</td> <td>2 1/2 cups</td> <td>3 cups</td> <td>4 cups</td> <td>5 cups</td> </tr> </table>	Rice	1/2 cup			1 cup	1 1/2 cups	2 cups	3 cups	4 cups	Hot tap water or soup stock (1 cup=250ml)	1 1/2 cups	2 cups	2 1/2 cups	3 cups	4 cups	5 cups		
Rice	1/2 cup	1 cup	1 1/2 cups	2 cups	3 cups	4 cups													
Hot tap water or soup stock (1 cup=250ml)	1 1/2 cups	2 cups	2 1/2 cups	3 cups	4 cups	5 cups													
2	Dry Pasta	1/2 - 4 cups	+60°C hot tap water	<ul style="list-style-type: none"> Place into a Pyrex® bowl and cover with hot tap water. Cook uncovered. When oven stops and STIR is displayed, stir and continue cooking. After cooking, stand and stir. 	3-5														
	<table border="1"> <tr> <td>Pasta</td> <td>1/2 cup</td> <td>1 cup</td> <td>1 1/2 cups</td> <td>2 cups</td> <td>3 cups</td> <td>4 cups</td> </tr> <tr> <td>Hot tap water (1 cup=250ml)</td> <td>2 cups</td> <td>2 1/2 cups</td> <td>3 cups</td> <td>4 cups</td> <td>5 cups</td> <td>6 cups</td> </tr> </table>	Pasta	1/2 cup			1 cup	1 1/2 cups	2 cups	3 cups	4 cups	Hot tap water (1 cup=250ml)	2 cups	2 1/2 cups	3 cups	4 cups	5 cups	6 cups		
Pasta	1/2 cup	1 cup	1 1/2 cups	2 cups	3 cups	4 cups													
Hot tap water (1 cup=250ml)	2 cups	2 1/2 cups	3 cups	4 cups	5 cups	6 cups													
3	Fresh Pasta Tortellini Ravioli Fettuccine	1/2 - 4 cups	+60°C hot tap water	<ul style="list-style-type: none"> Place into a Pyrex® bowl and cover with hot tap water. Cook uncovered. When oven stops and STIR is displayed, stir and continue cooking. After cooking, stand and stir. 	1-5														
	<table border="1"> <tr> <td>Pasta</td> <td>1/2 cup</td> <td>1 cup</td> <td>1 1/2 cups</td> <td>2 cups</td> <td>3 cups</td> <td>4 cups</td> </tr> <tr> <td>Hot tap water (1 cup=250ml)</td> <td>2 cups</td> <td>2 cups</td> <td>3 cups</td> <td>4 cups</td> <td>5 cups</td> <td>6 cups</td> </tr> </table>	Pasta	1/2 cup			1 cup	1 1/2 cups	2 cups	3 cups	4 cups	Hot tap water (1 cup=250ml)	2 cups	2 cups	3 cups	4 cups	5 cups	6 cups		
Pasta	1/2 cup	1 cup	1 1/2 cups	2 cups	3 cups	4 cups													
Hot tap water (1 cup=250ml)	2 cups	2 cups	3 cups	4 cups	5 cups	6 cups													
4	Instant Noodles	1 - 2 pkts (1 pkt = approx. 85g)	+60°C hot tap water	<ul style="list-style-type: none"> Place into a Pyrex® bowl and cover with hot tap water. Cook uncovered. When oven stops and STIR is displayed, stir and continue cooking. After cooking, stir then stand. <p>N.B. For small quantities, the food may not require a stir during the cooking.</p>	1-2														
	<table border="1"> <tr> <td>Noodles</td> <td>1 pkt</td> <td>2 pkts</td> </tr> <tr> <td>Hot tap water (1 cup=250ml)</td> <td>2 cups</td> <td>4 cups</td> </tr> </table>	Noodles	1 pkt			2 pkts	Hot tap water (1 cup=250ml)	2 cups	4 cups										
Noodles	1 pkt	2 pkts																	
Hot tap water (1 cup=250ml)	2 cups	4 cups																	
5	Frozen Pasta Tortellini Ravioli	1/2 - 4 cups	+60°C hot tap water	<ul style="list-style-type: none"> Place into a Pyrex® bowl and cover with hot tap water. Cook uncovered. When oven stops and STIR is displayed, stir and continue cooking. After cooking, stand and stir. 	1-5														
	<table border="1"> <tr> <td>Pasta</td> <td>1/2 cup</td> <td>1 cup</td> <td>1 1/2 cups</td> <td>2 cups</td> <td>3 cups</td> <td>4 cups</td> </tr> <tr> <td>Hot tap water (1 cup=250ml)</td> <td>2 cups</td> <td>2 1/2 cups</td> <td>3 cups</td> <td>4 cups</td> <td>5 cups</td> <td>6 cups</td> </tr> </table>	Pasta	1/2 cup			1 cup	1 1/2 cups	2 cups	3 cups	4 cups	Hot tap water (1 cup=250ml)	2 cups	2 1/2 cups	3 cups	4 cups	5 cups	6 cups		
Pasta	1/2 cup	1 cup	1 1/2 cups	2 cups	3 cups	4 cups													
Hot tap water (1 cup=250ml)	2 cups	2 1/2 cups	3 cups	4 cups	5 cups	6 cups													

RICE / PASTA / CEREAL MENU GUIDE

No.	Menu	 Weight Range	 Initial Temperature (approx.)	Procedure	 Standing Time (minutes)										
6	Porridge	1 - 4 serves	+20°C Room temperature	<ul style="list-style-type: none"> Place into a deep Pyrex® bowl and add water. Cook uncovered. When oven stops and STIR is displayed, stir and continue cooking. Stir after cooking. 											
						<table border="1"> <thead> <tr> <th></th> <th>Porridge</th> <th>Water</th> </tr> </thead> <tbody> <tr> <td>1serve</td> <td>1/3 cup</td> <td>3/4 cup</td> </tr> <tr> <td>2serves</td> <td>2/3 cup</td> <td>1 1/2 cups</td> </tr> <tr> <td>3serves</td> <td>1 cup</td> <td>2 1/4 cups</td> </tr> <tr> <td>4serves</td> <td>1 1/3 cups</td> <td>3 cups</td> </tr> </tbody> </table>		Porridge	Water	1serve	1/3 cup	3/4 cup	2serves	2/3 cup	1 1/2 cups
	Porridge	Water													
1serve	1/3 cup	3/4 cup													
2serves	2/3 cup	1 1/2 cups													
3serves	1 cup	2 1/4 cups													
4serves	1 1/3 cups	3 cups													



MEAT MENU GUIDE

Meat

When you cook the following menus with SENSOR COOK, press the MEAT pad until the desired menu appears in the display.

No.	Menu	Weight Range	Initial Temperature (approx.)	Procedure	Standing Time (minutes)
1	Roast Beef * You can select desired cooking result. MORE - Well done STD - Medium LESS - Rare	0.5-2.0 kg	+3°C Refrigerated	<ul style="list-style-type: none"> • Tie meat with string. • Place the meat on a small roasting rack fat side down in a casserole dish. • Cover with 2 sheets of plastic wrap. Ensure that the start and finish extends down the sides and at least 2cm across the bottom of the dish. Pierce both layers of plastic wrap with a carving fork 8 times around edges. (See diagrams on page ⑩) • When oven stops with REMOVE WRAP, DRAIN JUICE displayed, remove wrap, drain excessive juice, season and continue cooking. • When oven stops and TURN BEEF, OVER is displayed, turn beef over. • After cooking, stand covered with aluminium foil. 	5-15
2	Roast Lamb * You can select desired cooking result. MORE - Well done STD - Medium	0.5-2.0 kg	+3°C Refrigerated	<ul style="list-style-type: none"> • Place the meat on a small roasting rack fat side down in a casserole dish. • Cover with 2 sheets of plastic wrap. Ensure that the start and finish extends down the side and at least 2cm across the bottom of the dish. Pierce both layers of plastic wrap with a carving fork 8 times around edges. (See diagrams on page ⑩) • When oven stops with REMOVE WRAP, DRAIN JUICE displayed, remove wrap, drain excessive juice, season and continue cooking. • When oven stops and TURN LAMB, OVER is displayed, turn lamb over. • After cooking, stand covered with aluminium foil. 	5-15
3	Roast Chicken	1.0-2.5 kg	+3°C Refrigerated	<ul style="list-style-type: none"> • Remove neck, tail and excess fat from chicken. • Rinse inside of chicken with cold tap water. • Drain and dry chicken with paper towel. • Tie legs together prior cooking. • Place the chicken on a small roasting rack breast side down in a casserole dish. • Cover with 2 sheets of plastic wrap. Ensure that the start and finish extends down the side and at least 2cm across the bottom of the dish. Pierce both layers of plastic wrap with a carving fork 8 times around edges. (See diagrams on page ⑩) • When oven stops with REMOVE WRAP, DRAIN JUICE displayed, remove wrap, drain excessive juice, brush with butter, season and continue cooking. • When oven stops and TURN CHICKEN, OVER is displayed, turn chicken over and season. • After cooking, stand covered with aluminium foil. 	5-15
4	Corned Meat 1-2 tbsp. brown sugar 1-2 tbsp. malt vinegar 2-3 cups. hot tap water	0.5-2.0 kg	+3°C Refrigerated	<ul style="list-style-type: none"> • Place the meat in a casserole dish just large enough to contain it. • Add sugar, vinegar and water, cover with a casserole lid and cook. • When oven stops and TURN CORNED, MEAT OVER is displayed, turn corned meat over, and continue cooking. • After cooking, stand covered with aluminium foil. • Serve hot or cold as required. 	5-10
5	Casserole	1-4 serves		<ul style="list-style-type: none"> • See recipes on page ⑪. 	
6	Seasoned Roast	0.5-2.5 kg	+3°C Refrigerated	<ul style="list-style-type: none"> • See recipes on page ⑫ and diagrams on page ⑩. 	

MEAT MENU GUIDE

No.	Menu	 Weight Range	 Initial Temperature (approx.)	Procedure	 Standing Time (minutes)
7	Fish Fillets eg. Sea perch 1 tsp butter/fillet 1/2 tsp lemon juice/fillet	0.1-0.6 kg	+3°C Refrigerated	<ul style="list-style-type: none"> • Arrange in a flan dish or a casserole dish in a single layer. (Fold under the thin edges of the fish.) • Top with lemon juice and butter. • Cover with plastic wrap or glass lid. • After cooking, stand covered. 	1-3

- NOTE: 1. If you wish to cook more than 2.0 kg of beef or lamb, cook manually using times and power level supplied in the cookbook Roasting chart.
 2. For Roast Beef, Roast Lamb, Roast Chicken and Seasoned Roast, you may be required to turn meat over upon removing the plastic wrap. The oven display will inform when to follow this procedure.
 3. To cover meats with 2 layers of plastic wrap, follow these diagrams.

1. 1st layer

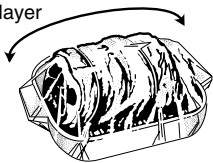

2. 2nd layer

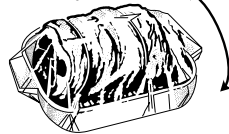

3. Pierce 8 times with a carving fork

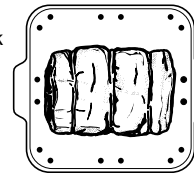

MEAT RECIPES

CASSEROLE

Apricot Chicken

Serves	1 serve	2 serves	3 serves	4 serves	
Ingredients;	chicken breast fillets, cubed	250 g	500 g	750 g	1000 g
	flour	1 tbs	1 1/2 tbs	2 tbs	2 tbs
	French onion soup mix	1/2 pkt	1 pkt	1 1/2 pkts	2 pkts
	apricot nectar	125 ml	250 ml	375 ml	500 ml
	dried apricot, halved	100 g	200 g	300 g	400 g

1. Toss chicken in combined French onion soup mix and plain flour.
2. Place into a casserole dish and cover with a glass lid.
3. Cook on Sensor Cook MEAT 5 "Casserole".
4. The oven will stop and display STIR. At this stage stir the casserole. Cover with lid and press START pad to continue cooking. The oven will stop again and display ADD STIR, at this stage add apricot nectar and apricots. Cover with lid. Press START pad to continue cooking.
5. After cooking, stir and stand, covered 2–5 minutes before serving.

Beef Stroganoff

Serves	1 serve	2 serves	3 serves	4 serves	
Ingredients;	rump steak, cubed	250 g	500 g	750 g	1 kg
	plain flour	2 tbs	1/4 cup	1/3 cup	1/2 cup
	salt and pepper	to taste	to taste	to taste	to taste
	onion, chopped	1/2 (small)	1 (small)	1	1
	tomato puree	2 ts	1 tbs	1 1/2 tbs	2 tbs
	beef stock	125 ml	200 ml	250 ml	375 ml
	red wine	60 ml	60 ml	60 ml	60 ml
	mushroom, thinly sliced	25 g	50 g	75 g	100 g
	sour cream	75 ml	150 ml	200 ml	300 ml

1. Toss steak with flour, salt and pepper in a freezer bag until evenly coated.
2. Place steak, left over flour, onion, tomato puree, beef stock and wine into a casserole dish.
3. Cover with a glass lid and Cook on Sensor Cook MEAT 5 "Casserole".
4. The oven will stop and display STIR. At this stage stir the casserole. Cover with lid and press START pad to continue cooking. The oven will stop again and display ADD STIR, at this stage stir the casserole and add mushrooms. Cover with lid. Press START pad to continue cooking.
5. After cooking stir in sour cream and stand, covered 2–5 minutes. Serve hot with boiled rice or pasta.

Springtime Lamb Casserole

Serves	1 serve	2 serves	3 serves	4 serves	
Ingredients;	lamb, cubed	250 g	500 g	750 g	1 kg
	French onion soup mix	1/2 pkt	1 pkt	1 1/2 pkts	2 pkts
	plain flour	2 tbs	4 tbs	1/4 cup	1/4 cup
	spring onion, chopped	1	2	3	4
	small carrot, sliced	1	2	2	2
	chicken stock	1/2 cup	1/2 cup	3/4 cup	1 cup
	corn kernels	60 g	125 g	310 g	310 g
	celery	1 stick	1 stick	2 sticks	2 sticks
	sour cream (optional)	75 ml	150 ml	200 ml	300 ml

1. Toss lamb in combined French onion soup mix and flour in a freezer bag until evenly coated.
2. Place lamb left over flour, onion, carrot and chicken stock in a casserole dish.
3. Cover with a glass lid and cook on Sensor Cook MEAT 5 "Casserole".
4. The oven will stop and display STIR. At this stage stir the casserole. Cover with lid and press START pad to continue cooking. The oven will stop again and display ADD STIR at this stage stir the casserole, add the corn and celery. Cover with lid. Press START pad to continue cooking.
5. After cooking, stir in sour cream (optional) and stand, covered 2–5 minutes before serving.

N.B. For small quantities, the food may require one stir only during the cooking. The oven display will inform when to follow this procedure.

MEAT RECIPES

SEASONED ROAST

Apple and Sage Pork

boned loin pork (with rind on)

Seasoning

- 1-2 cups sage and onion stuffing mix
- 1/2 cup dried apples, chopped
- 8-10 prunes, pitted and chopped
- 125 g toasted silvered almonds

1. Following instructions on the packet prepare stuffing.
2. Add apples, prunes and almonds. Mix well.
3. Pack loosely down the centre of meat. Roll up tightly and secure with string.
4. Sprinkle rind with salt.
5. Place the meat on a small roasting rack fat side down in a casserole dish.
6. Cover with 2 sheets of plastic wrap. Ensure that the start and finish extends down the sides and at least 2cm across the bottom of the dish. Pierce both layers of plastic wrap with a carving fork 8 times around edges. (See page 10)
7. Cook on Sensor Cook MEAT 6 "Seasoned Roast".
8. When oven stops with REMOVE WRAP, DRAIN JUICE displayed, remove wrap, drain excessive juice, season and continue cooking. when oven stops and TURN MEAT, OVER is displayed, turn meat over and season.
9. After cooking, stand covered with aluminium foil 5-15 mins. before carving.

Fruity Beef

topside beef

Sauce

- 125 ml fruit chutney
- 1 tablespoon oil
- 1 tablespoon Worcestershire Sauce
- 1 tablespoon curry powder
- 2 teaspoons mustard powder
- 1 tablespoon sweet sherry

Seasoning

- 1 1/2 cups stuffing mix
- water to mix

1. Prepare beef to be seasoned by cutting a pocket in the centre.
2. Mix sauce ingredients together and put to one side.
3. Prepare enough seasoning by following instructions on the packet. Place loosely into prepared packet. Tie meat with string.
4. Brush sauce over meat. Place the meat on a small roasting rack fat side down in a casserole dish.
5. Cover with 2 sheets of plastic wrap. Ensure that the start and finish extends down the sides and at least 2cm across the bottom of the dish. Pierce both layers of plastic wrap with a carving fork 8 times around edges. (See page 10)
6. Cook on Sensor Cook MEAT 6 "Seasoned Roast".

7. When oven stops with REMOVE WRAP, DRAIN JUICE displayed, remove wrap, drain excessive juice, season and continue cooking. when oven stops and TURN MEAT, OVER is displayed, turn meat over and season.
 8. After cooking, stand covered with aluminium foil 5-15 mins. before carving.
- NOTE: Baste meat 2-3 times during cooking with prepared sauce after plastic wrap is removed.

Apricot Lamb

loin of forequarter lamb (deboned)



- 1 packet dried apricots
- 250 ml apricot nectar
- 1 tablespoon cornflour

1. Unroll meat. Place dried apricots down the centre 2 rows deep.
2. Roll up tightly and secure with string.
3. Mix apricot nectar with cornflour and heat for 3-4 mins. on HIGH or until boil. Allow to cool slightly.
4. Pour apricot juice over the meat and marinade 1-2 hours.
5. Remove meat from the marinade, place the meat on a small roasting rack fat side down in a casserole dish.
6. Cover with 2 sheets of plastic wrap. Ensure that the start and finish extends down the sides and at least 2cm across the bottom of the dish. Pierce both layers of plastic wrap with a carving fork 8 times around edges. (See page 10)
7. Cook on Sensor Cook MEAT 6 "Seasoned Roast".
8. When oven stops with REMOVE WRAP, DRAIN JUICE displayed, remove wrap, drain excessive juice, season and continue cooking. when oven stops and TURN MEAT, OVER is displayed, turn meat over and season.
9. After cooking, stand covered with aluminium foil 5-15 mins. before carving.

DESSERTS MENU GUIDE

Desserts



When you cook the following menus with SENSOR COOK, press the DESSERTS pad until the desired menu appears in the display.

No.	Menu	 Weight Range	 Initial Temperature (approx.)	Procedure	 Standing Time (minutes)	
1	Cake Packet cake	1 packet	+20°C Room temperature	<ul style="list-style-type: none"> Follow ingredient instructions on packet. Mix all ingredients with a fork thoroughly. Pour into microwave ring container. –Approx. 21 cm. After cooking stand before turning out. 	3	
2	Stewed Fruit Fruit (apples, pears etc.)	0.1-1.0 kg	+3°C Refrigerated	<ul style="list-style-type: none"> Wash, peel and core fruit. Remove stone if necessary and slice thinly. Place in a Pyrex® bowl. Cover with a glass lid or plastic wrap. After cooking, stand covered and stir. 	1–5	
3	 pudding	2 – 8 serves			<ul style="list-style-type: none"> Combine flour, cocoa, caster sugar in a pudding bowl. Stir in milk, chocolate and butter. Mix until smooth. In a separate bowl, mix brown sugar, extra cocoa powder and boiling water. Pour over mixture. After cooking, stand. 	3–5
	Serve	2-4 serves	4-6 serves	6-8 serves		
	Ingredients;	Self-Raising Flour cocoa powder caster sugar milk dark cooking chocolate, melted butter, melted brown sugar cocoa, extra boiling water	1/2 cup 1 tbs 1/4 cup 1/4 cup 50 g 30 g 1/2 cup 1 tbs 1 cup	3/4 cup 2 tbs 1/3 cup 1/2 cup 100 g 60 g 3/4 cup 2 tbs 1 1/2 cups	1 1/4 cups 3 tbs 1/2 cup 3/4 cup 150 g 90 g 1 1/4 cups 3 tbs 2 1/2 cups	
4	Crunch	2 – 8 serves			<ul style="list-style-type: none"> Place pie apple in a shallow dish. Sprinkle evenly with dry cake mix. Layer sliced butter over cake mix. Combine brown sugar, coconut, nuts and cinnamon. Sprinkle over butter. After cooking, stand. 	3–5
	Serve	2-4 serves	4-6 serves	6-8 serves		
	Ingredients;	can pie apples White Wings butter cake mix butter, cut into thin slices brown sugar coconut crushed nuts cinnamon	400 g 1/2 cup 50 g 1 tbs 1 tbs 1 tbs 1/2 ts	600 g 3/4 cup 75 g 2 tbs 2 tbs 2 tbs 1 ts	800 g 1 1/2 cups 150 g 3 tbs 3 tbs 3 tbs 1 ts	
5	Muesli Delight	2 – 8 serves			<ul style="list-style-type: none"> Spread sour cream evenly over base of pie plate. Sprinkle with drained peaches. Combine butter cake mix, muesli, coconut and butter. Mix well. Spread muesli over peaches. After cooking, stand. 	3–5
	Serve	2-4 serves	4-6 serves	6-8 serves		
	Ingredients;	sour cream can sliced peaches, drained White Wings butter cake mix toasted muesli coconut butter, melted	3/4 x 300 g carton 425 g can 1/2 cup 3/4 cup 2 tbs 75 g	300 g carton 825 g can 1 cup 1 1/2 cups 1/4 cup 125 g	300 g carton 3 x 425 g can 1 cup 2 cups 1/2 cup 175 g	

EXPRESS DEFROST MENU GUIDE

Express
Defrost

When you defrost the following menus with EXPRESS DEFROST, press the EXPRESS DEFROST pad until the desired menu appears in the display.



No.	Menu	Quantity min-max (kg's)	Procedure	Standing Time (minutes)
1	Fish Fillets 	0.5	<ul style="list-style-type: none"> Place fish fillets on a defrost rack. When the oven has stopped, turn over and separate into pieces. After defrost time, stand covered with aluminium foil. 	5
2	Chicken Fillets 	0.5	<ul style="list-style-type: none"> Place chicken fillets on a defrost rack. When the oven has stopped, turn over and separate into pieces. After defrost time, stand covered with aluminium foil. 	5
3	Sausages / Minced Meat 	0.5	<ul style="list-style-type: none"> Place sausages / minced meat on a defrost rack. When the oven has stopped, remove defrosted portions of mince, turn over and shield edges with foil strips. After defrost time, stand covered with aluminium foil. 	5

NOTE: When freezing minced meat, shape it into flat even sizes.
For fish fillets, chicken fillets and sausages freeze separately in single flat layers and if necessary separate into layers with freezer plastic.
This will ensure even defrosting.
It is also a good idea to label the packs with the correct weights.

EASY DEFROST MENU GUIDE

Easy
Defrost

When you defrost the following menus with EASY DEFROST, press the EASY DEFROST pad until the desired menu appears in the display.

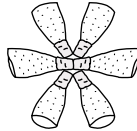
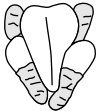
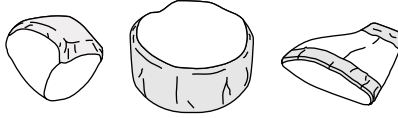
No.	Menu	Quantity min-max (kg's)	Procedure	Standing Time (minutes)
1	Minced Meat Beef 	0.1-3.0	<ul style="list-style-type: none"> Place frozen minced meat on a defrost rack. Shield edge. When the oven has stopped, remove defrosted portions of mince, turn over and shield edges with foil strips. After defrost time, stand covered with aluminium foil. See NOTE below. 	5-20
2	Steak/Chops Fish Fillets 	0.1-3.0 0.1-1.0	<ul style="list-style-type: none"> Shield thin end of chops or steaks with foil. Position the food with thinner parts in the centre in a single layer on a defrost rack. If pieces are stuck together, try to separate as soon as possible. When the oven has stopped, remove defrosted pieces, turn over and shield the warm portions of remaining pieces. After defrost time, stand covered with aluminium foil. See NOTE below. 	5-30 (Steak/ Chops) 10-15 (Fish fillets)
3	Chicken Pieces 	0.1-3.0	<ul style="list-style-type: none"> Shield the exposed bone with foil. Place chicken pieces on a defrost rack. When the oven has stopped, remove any defrosted pieces, turn over and shield the warm portions of remaining pieces. After defrost time, stand covered with aluminium foil. See NOTE below. 	5-15
4	Poultry 	1.0-4.0	<ul style="list-style-type: none"> Remove from original wrapper. Shield wing and leg tips with foil. Place breast side down on a defrost rack. When the oven has stopped, turn over and shield the warm portions. After defrost time, stand covered with aluminium foil. <p>N.B. After standing run under cold water to remove giblets if necessary.</p>	5-50
5	Roast Meat Beef/Pork Lamb 	0.5-3.0 0.5-2.5	<ul style="list-style-type: none"> Shield the bone and the edge with foil strips about 2.5cm wide. Place joint with lean side face upwards (if possible) on a defrost rack. When the oven has stopped, turn over and shield the warm portions. After defrost time, stand covered with aluminium foil. 	5-60
6	Bread	1-6 slices (1slice, approx. 30g)	<ul style="list-style-type: none"> Separate slices and place between paper towel on turntable. After defrosting, stand. 	1

Foods not listed in the Guide can be defrosted using M•LOW setting.

NOTE: When freezing minced meat, shape it into flat even sizes.

For chicken pieces, steaks and chops, freeze separately in single flat layers and if necessary separate into layers with freezer plastic.

This will ensure even defrosting.

It is also a good idea to label the packs with the correct weights.

RECIPES

INDEX

MEAT

APRICOT AND ALMOND CRUSTY LAMB
BEEF STROGANOFF
CHILLI CON CARNE
CHINESE BEEF
CORNER MEAT
CRUSTY ROSEMARY LAMB
GOLDEN CURRY SAUSAGES
HERBED LOIN OF LAMB
HONEY ROAST LAMB
INDIAN CURRY LAMB
ITALIAN SPAGHETTI SAUCE
LASAGNE
MINTED PICNIC LOAF
SHEPHERD'S PIE
SPRINGTIME LAMB CASSEROLE
VEAL Á LA MEDALLION
VEAL AND AUBERGINE

POULTRY

APRICOT CHICKEN
CHICKEN AND PENNE SALAD
CHICKEN AND MACARONI BAKE
CHICKEN CACCIATORE
CHICKEN FILLET BURGERS
CHICKEN FRICASSEE
CHICKEN IN A POT
CHICKEN PROVENCE
CHICKEN TERRINE
CHICKEN WITH BACON AND
LEEK SEASONING
CRUNCHY CAMEMBERT CHICKEN
HONEY CHICKEN LEGS
ROAST CHICKEN
SEASONED CHICKEN PARCELS
TANDOORI CHICKEN

SEAFOOD

AVOCADO SCALLOPS
BOUILLABAISSA
CHEESY SALMON CANNELLONI
CRAB MORNAY
GARLIC MUSSELS
GARLIC PRAWNS
PAELLA
PRAWN CREOLE
SEAFOOD LAKSA
SEAFOOD LASAGNE
SESAME PRAWNS
SMOKED SALMON TAGLIATELLE
SQUID IN TOMATO AND WINE SAUCE
THAI SCALLOPS WITH VERCAMILLI
NOODLES

VEGETABLES

CAULIFLOWER AU GRATIN
CAULIFLOWER POLONAISE
CHOKOS WITH SOUR CREAM AND BACON
EASY HOME-MADE RICE RISOTTO
HONEY CARROTS
HONEY GINGERED VEGETABLES
HOT CURRIED SLAW
MINISTRONE
POTATOES PIZZAIOLA
POTATO, AVOCADO AND ONION SALAD
PUMPKIN SALAD
SCALLOPED POTATOES
SQUASH WITH YOGHURT
STUFFED BAKED POTATOES
SUNSHINE BRUSSELS SPROUTS
VEGETABLE PLATTER

DESSERTS

AUSTRALIAN FRUIT CAKE
BAKED APPLES
BREAD AND BUTTER PUDDING
CALIFORNIAN APPLE CRUNCH
CARAMEL RICE PUDDING
CHOCOLATE MOUSSE
CHOCOLATE CAKE
CHOCOLATE SELF-SAUCING PUDDING

MEAT

CRUSTY ROSEMARY LAMB

Serves 4-6

- 1/4 cup brown sugar**
- 2 tablespoons seeded mustard**
- 1 tablespoon lemon juice**
- 2 tablespoons chopped fresh rosemary**
- 1.5 kg leg lamb**

1. Combine brown sugar, mustard, lemon juice and rosemary in a small bowl.
2. Place fat side down on a rack.
3. Cook for 25-27 minutes on MEDIUM HIGH (for medium) or 33-35 minutes on MEDIUM HIGH (for well done).
4. Turn over halfway through cooking, shielding shank with foil to prevent overcooking. Spread combined ingredients over leg of lamb. Allow to stand 10 minutes covered with foil before carving.

SHEPHERD'S PIE

Serves 6-8

- | | |
|--|--|
| 4 large potatoes (approx.1 kg) | 2 tablespoons gravy powder |
| butter | 420 g can minestrone soup |
| milk | 1 tablespoon Worcestershire sauce |
| 2 tablespoons fresh chives, chopped | 1 tomato, chopped |
| salt and pepper | 2 tablespoons parsley |
| 1 kg minced beef | 60 g grated cheddar cheese |
| 1 onion, chopped | |

1. Peel and cut potatoes into 2.5 cm cubes. Place in a large bowl. Add 2 tablespoons water; cover and cook for 12-14 minutes on HIGH or until tender. Drain.
2. Mash potatoes; add butter, milk, chives, salt and pepper until smooth consistency forms.
3. In a large bowl, combine mince and onion and cook for 10-12 minutes on MEDIUM HIGH, stirring every 2 minutes. Drain juices from meat.
4. Add gravy powder, minestrone soup, Worcestershire sauce, tomato and parsley. Mix well.
5. Spoon mixture into a 25 x 20 cm rectangular dish.
6. Spread mashed potato evenly over top of mixture. Sprinkle cheese on top.
7. Cook for 20-22 minutes on MEDIUM HIGH.
8. Allow to stand covered with foil for 10 minutes before serving.

LASAGNE

Serves 8

MEAT SAUCE INGREDIENTS

- 30 g butter**
- 1 onion, chopped**
- 1 kg topside mince**
- 1/4 cup tomato paste**
- 240 g jar neopolitana sauce**
- 1 cup fresh button mushrooms, sliced**
- 2 cloves garlic, crushed (optional)**
- 1 tablespoon fresh oregano**

CHEESE SAUCE INGREDIENTS

- 90 g butter**
- 1/3 cup flour**
- 1 3/4 cups milk**
- 125 g tasty cheese, grated**
- 200 g packet instant lasagne noodles**
- 100 g mozzarella cheese, grated**

MEAT SAUCE METHOD

1. Place butter and onion in a Pyrex bowl. Cook for 2-3 minutes on HIGH.
2. Stir in mince. Cook, uncovered, for 12-14 minutes on MEDIUM HIGH, stirring every 2 minutes. Drain excess fat.
3. Stir in tomato paste, neopolitana sauce, mushrooms, garlic and oregano.

CHEESE SAUCE METHOD

1. Melt butter for 40-50 seconds on HIGH. Stir in flour; cook for further 40-50 seconds on HIGH.
2. Gradually stir in milk. Cook for 4-6 minutes on HIGH, stirring every minute.
3. Stir in tasty cheese.

TO ASSEMBLE

1. Use a 20 x 20 cm deep casserole dish
2. Dip lasagne sheets in hot water, then cover base of dish.
3. Spoon over sheets one-third of meat sauce. Cover with one-third of cheese sauce.
4. Repeat the process 3 times, ending with the cheese sauce.
5. Sprinkle with mozzarella cheese.
6. Cook for 20-22 minutes on MEDIUM HIGH.
7. Allow to stand 10 minutes before serving.
8. Serve with a fresh garden salad and bread.

SPRINGTIME LAMB CASSEROLE

Serves 4

1½ packets (45 g) French onion soup
¼ cup plain flour
750 g lamb, cubed
3 spring onions, quartered
2 carrots, thinly sliced
¾ cup chicken stock
310 g can corn kernels, drained
2 sticks celery, finely chopped
200 mL carton sour cream

2 teaspoons parsley
2 teaspoons chives

1. Combine French onion soup mix and flour in a 2-3-litre casserole dish. Toss the lamb in flour mixture, coating thoroughly.
2. Add onions and carrots, stir in chicken stock and mix well.
3. Cover and cook for 20-22 minutes on MEDIUM, stirring during cooking.
4. Add corn, celery, parsley and chives. Mix well.
5. Cook a further 4-5 minutes on MEDIUM.
6. Add sour cream, stand covered for 3 minutes.

GOLDEN CURRY SAUSAGES

Serves 4-6

1 kg sausages
1 onion, finely sliced
2 tablespoons butter
3 teaspoons curry powder
1½ cups water

2 tablespoons plain flour
1 carrot, grated
2 tablespoons Worcestershire sauce
1 tablespoon brown sugar
2 tablespoons brown vinegar

1. Pierce sausages with a fork twice. Arrange on a microwave rack.
2. Cook sausages for 14-16 minutes on MEDIUM, turning halfway through cooking. After cooled, slice into rounds.
3. Mix sugar, vinegar, curry powder, flour, Worcestershire sauce and water together in a jug.
4. In a 3-litre casserole dish combine butter, onions and cook for 2-3 minutes on HIGH, or until onions become transparent.
5. Add carrot, sausages and sauce. Mix well and cook for an extra 6-7 minutes on MEDIUM.
6. Serve hot with Balsmati rice and pappadums.

BEEF STROGANOFF

Serves 6

1 kg rump steak, cut into strips
½ cup plain flour
salt and pepper
1 onion, finely chopped
2 tablespoons tomato purée
1½ cups beef stock
¼ cup red wine
100 g mushrooms, thinly sliced
300 mL sour cream

1. Toss steak with flour, salt and pepper in a freezer bag until evenly coated.
2. Place steak, left-over flour, onion, tomato purée, beef stock and red wine in a 3-litre casserole dish.
3. Cook, covered, for 24-26 minutes on MEDIUM, stirring twice during cooking.
4. Stir in mushrooms and sour cream. Cook for a further 7-8 minutes on MEDIUM.
5. Serve with boiled rice.

CORNE MEAT

Serves 6-8

2 tablespoons brown sugar
2 tablespoons malt vinegar
4 cups hot water
1.5 kg corned meat

1. Place corned meat in a casserole dish just large enough to contain it.
2. Add sugar, vinegar and water.
3. Cover with lid and cook for 64-66 minutes on MEDIUM, turning over halfway through cooking. Allow to stand covered with foil for 10 minutes before serving.
4. Serve with white sauce.

VEAL À LA MEDALLION

Serves 4-6

1 kg veal, cubed
1/2 cup plain flour
salt and pepper
3/4 cup water
1 cup finely chopped shallots
2 carrots, thinly sliced

1/2 teaspoon grated lemon rind
2 rashers bacon, chopped
250 g fresh mushrooms, sliced
300 mL carton sour cream
1 tablespoon chopped chives

1. Toss veal in flour. Place in a 3-litre casserole dish. Stir in salt, pepper, water, shallots, carrots, lemon rind and bacon.
2. Cover and cook for 34-36 minutes on MEDIUM, stirring 2-3 times during cooking.
3. Stir in mushrooms and sour cream.
4. Cover and cook a further 5-7 minutes on MEDIUM.
5. Sprinkle with chives.

VEAL AND AUBERGINE

Serves 4-6

750 g veal, diced
1 large aubergine or eggplant, cubed
1 tablespoon flour
2 teaspoons fresh sage
black pepper to taste
1 teaspoon chicken stock powder
4 rashers bacon, chopped
3 shallots, sliced
1 yellow capsicum, sliced
420 g can peeled tomatoes
2 tablespoons continental parsley, chopped
2 tablespoons tomato paste

1. Toss veal in combined flour, fresh sage, chicken stock powder and black pepper.
2. Stir in bacon, shallots, crushed tomato, yellow capsicum, tomato paste and aubergine.
3. Cover and cook for 32-34 minutes on MEDIUM, stirring 2-3 times during cooking.
4. Sprinkle with parsley and serve with rice and Kalamata olives.

HERBED LOIN OF LAMB

Serves 8

1/2 cup white wine
1/4 cup oil
3 cloves garlic, crushed
freshly ground black pepper
2 teaspoons rosemary spikes
1 kg loin of lamb

1. Mix all ingredients except lamb together to form a marinade.
2. Place loin of lamb in large shallow dish and pour over marinade; leave overnight.
3. Remove loin of lamb from marinade and roll loin tightly, securing with string.
4. Place on a rack. Cook for 20 minutes on MEDIUM (for medium) or 24 minutes on MEDIUM (for well done). Turn meat over halfway through cooking.
5. Allow to stand 10 minutes covered with foil before carving.

ITALIAN SPAGHETTI SAUCE

Serves 4-6

500 g topside mince
1 onion, chopped
2 clove garlic, crushed
410 g can whole tomatoes
1/2 cup tomato paste
100 g mushrooms, sliced
1 tablespoon chopped parsley
1 tablespoon fresh oregano leaves
1 tablespoon fresh basil leaves

1. Mix mince, onion and garlic together in a large bowl. Cook for 8-10 minutes on MEDIUM HIGH, stirring every 2 minutes. Drain well.
2. Stir in canned tomatoes, tomato paste, mushrooms, parsley, salt, oregano and basil.
3. Cook a further 6-8 minutes on MEDIUM HIGH. Stir halfway through cooking.
4. Serve over hot spaghetti.

CHINESE BEEF

Serves 4-6

750 g blade or round steak, cubed **200 g Fresh baby corn**
1 large onion, sliced **2 tablespoons sesame oil**
2 carrots, thinly sliced **170 g snow peas, sliced**
1 clove garlic, crushed **1 red capsicum, sliced**
1/2 cup beef stock **8 tablespoons oyster sauce**
1/2 cup oyster sauce **7 tablespoons sesame seeds**

1. In a 3-litre casserole dish, combine meat , garlic and sesame oil; mix well. Cook 1 minute on HIGH.
2. Add onions and carrots.
3. In a jug, combine beef stock, oyster sauce; stir well. Pour over beef.
4. Cook, covered, for 20-22 minutes on MEDIUM, stirring 2-3 times during cooking.
5. Add baby corn and capsicum. Cover and cook a further 10-11 minutes on MEDIUM, stirring once during cooking.
6. Add snow peas cover and cook 2-3 minutes on MEDIUM. Stir once.
7. Sprinkle toasted sesame seeds over the top.

INDIAN CURRY LAMB

Serves 4-6

1 small sweet potato, cubed **1 tablespoon curry paste**
1 onion, thinly sliced **400 g can of chickpeas**
1 kg lamb, trimmed and cubed **3 cubed zucchini**
1 cup chicken stock **2 tablespoons fresh coriander or**
1 teaspoon chicken stock powder, **parsley, chopped**
extra

1. Place onion and curry paste in a dish, cook for 1 minute on MEDIUM HIGH.
2. Place onion, lamb, sweet potato, chicken stock and stock powder into a 3-litre casserole dish.
3. Cover and cook for 28-30 minutes on MEDIUM, stirring twice during cooking.
4. Add zucchini and cook for a further 1-2 minutes on HIGH.
5. Combine lamb, canned chickpeas and stock mixture in a 3-litre casserole dish and cover.
6. Heat through for 6-8 minutes on MEDIUM.
7. Stir through coriander, and serve.

MINTED PICNIC LOAF

Serves 6-8

2 cloves garlic **500 g sausage mince**
140 g can crushed tomato **500 g minced beef**
1 packet tomato soup mix **2 tablespoons chopped fresh mint**
1 onion, minced

TOPPING

1 cup grated fresh tasty cheese
1 cup stale breadcrumbs
1 tablespoon chopped fresh mint

1. Mix onion, garlic, tomato and soup mix in bowl.
2. Add mince and mint; mix well.
3. Press mixture into an 11 x 25 cm loaf dish lined with paper towels.
4. Cook for 22-24 minutes on MEDIUM HIGH.
5. Drain excess liquid from loaf dish.

TOPPING

1. Combine topping ingredients and press evenly over loaf. Cook for a further 7-8 minutes on MEDIUM HIGH.
2. Allow to stand 10 minutes before turning out. Serve hot or cold.

CHILLI CON CARNE

Serves 4-6

1 kg mince **1 tablespoon vinegar**
1 large onion, finely chopped **1 teaspoon sugar**
825 g can peeled tomatoes **375 g jar tomato paste**
salt and pepper **425 g can red kidney beans, drained**
1-2 teaspoons chilli powder

1. Mix mince and onion together in a large bowl. Cook for 10-12 minutes on MEDIUM HIGH, stirring every 2 minutes. Drain excess liquid.
2. Stir in tomatoes, salt and pepper, chilli powder, vinegar, sugar, tomato paste and kidney beans.
3. Cook for 18-20 minutes on MEDIUM HIGH, stirring twice during cooking.
4. Serve with boiled rice.

APRICOT AND ALMOND CRUSTY LAMB

Serves 4

100 g dried apricots, finely chopped

1/4 cup shelled blanched almonds

1/4 cup ground almonds

1 teaspoons dried rosemary

1 egg, lightly beaten

1 rack of lamb (approx. 8 chops)

1 tablespoon apricot jam

1/2 cup breadcrumbs

1. Mix together apricots, breadcrumbs, ground almonds, rosemary and egg.
2. Brush lamb with apricot jam.
3. Place apricot crust on top of lamb.
4. Place on a microwave rack. Cook for 20-24 minutes on MEDIUM. Allow to stand 10 minutes before carving.

HONEY ROAST LAMB

Serves 4-6

1.5 kg leg lamb

3 tablespoons honey

1 tablespoon Dijon mustard

1. Combine honey and Dijon mustard. Brush over lamb.
2. Place fat-side down on a roasting rack.
3. Cook for 26-28 minutes on MEDIUM HIGH (for medium) or 32-34 minutes on MEDIUM HIGH (for well done).
4. Turn over halfway through cooking shielding shank with foil to prevent overcooking. Brush combined ingredients over leg of lamb. Allow to stand 10 minutes covered with foil before carving.

POULTRY

CHICKEN IN A POT

Serves 4-6

1.5 kg chicken thighs
1/4 cup plain flour
2 rashers bacon, finely chopped
1 green capsicum, diced
1 onion, finely chopped
425 g can peeled tomatoes

2 tablespoons tomato paste
2 chicken stock cubes
1 tablespoon soy sauce
salt and pepper
200 g mushrooms, sliced

1. Toss chicken thighs in flour.
2. Combine all ingredients, except mushrooms, in a 3-litre casserole dish.
3. Cover and cook for 30-33 minutes on MEDIUM HIGH. Stir 2-3 times during cooking.
4. Add mushrooms. Cook, uncovered, a further 5-7 minutes on MEDIUM HIGH.

CHICKEN FRICASSEE

Serves 4

1 large cooked chicken
60 g butter
3 tablespoons flour
2 cups chicken stock
1 egg yolk

1/4 cup cream
1/4 teaspoon nutmeg
400 g drained artichoke hearts
1/2 cup grated cheddar cheese

1. Remove meat from chicken and chop into cubes.
2. Melt butter for 40-50 seconds on HIGH in a jug. Stir in flour, cook a further 40 seconds.
3. Gradually stir in chicken stock. Cook for 6-8 minutes on HIGH, stirring halfway through cooking.
4. Stir in chopped chicken, egg yolk, cream, nutmeg and artichokes.
5. Pour into a 1 1/2-litre casserole dish. Sprinkle cheese over the top. Cook a further 10-12 minutes on MEDIUM.

CHICKEN WITH BACON AND LEEK SEASONING

Serves 4

No.15 chicken
60 g butter, melted
1 leek, finely chopped
2 rashers bacon, chopped

1 1/2 cups wholemeal breadcrumbs
1 egg yolk
salt and pepper
20 g butter, melted, extra

1. Combine butter, leek and bacon in a bowl. Cook for 1-2 minutes on HIGH.
2. Stir in breadcrumbs, egg yolk and seasonings. Mix well.
3. Fill cavity of chicken with stuffing and secure with a toothpick.
4. Brush chicken with extra melted butter.
5. Place chicken on a rack, breast-side down, cook for 14-16 minutes on MEDIUM HIGH.
6. Turn over, cook a further 14-16 minutes on MEDIUM HIGH.
7. Stand covered with foil for 10 minutes before carving.

CHICKEN AND PENNE SALAD

Serves 6

No.15 chicken
20 g butter
1 packet picador cheese
1 cup chicken stock
1/2 red capsicum, chopped
1/2 yellow capsicum, chopped
1 stick celery, chopped
2 cups penne pasta
4 cups hot tap water
1 tablespoon fresh chives

1. Brush chicken with butter melted for 20 seconds on HIGH.
2. Cook chicken for 28-32 minutes on MEDIUM HIGH turning over halfway through cooking.
3. Cool and then remove chicken flesh from the bone.
4. Cook pasta in a large bowl for 15-16 minutes on HIGH. Stand for 5 minutes, stir and strain. Set aside to cool.
5. Melt cheese by combining with chicken stock in a bowl and cooking on HIGH for 2 minutes.
6. Combine all other ingredients and mix well with chicken, pasta and sauce.

CHICKEN PROVENCALE

Serves 4

1/2 cup white wine
425 g can peeled tomatoes
1 large onion, chopped
1 apple, peeled and chopped
1/2 cup black olives

1 teaspoon curry powder
1.25 kg chicken pieces
(or 4 marylands)
250 g button mushrooms
chopped parsley

1. In a large jug combine wine, tomatoes, onion, apple, olives and curry powder. Mix well.
2. Arrange chicken pieces in a casserole dish. Pour over sauce. Cover and cook for 24-26 minutes on MEDIUM HIGH. Stir once during cooking.
3. When oven stops, stir in mushrooms. Cover and cook for a further 3-4 minutes on MEDIUM HIGH.
4. Sprinkle with parsley.

CHICKEN TERRINE

Serves 6-8

60 g butter
6 shallots, chopped
1/2 cup flour
1 cup chicken stock
1 cup milk
1/4 teaspoon tabasco sauce
pepper

250 g cream cheese, softened
1 cooked chicken, chopped
2 teaspoons green peppercorns,
chopped
3 teaspoons gelatine
1/2 cup water
6 rashers bacon

1. Melt butter for 50-60 seconds on HIGH. Add shallots and flour. Cook for 1 minute on HIGH.
2. Gradually stir in stock and milk. Cook for 4-5 minutes on HIGH, stirring every 2 minutes.
3. Stir in tabasco sauce and pepper.
4. Beat cream cheese. Gradually stir in the sauce. Add chicken and peppercorns.
5. Dissolve gelatine in water. Cook for 40 seconds -1 minute on HIGH; add to chicken mixture.
6. Line 25 x 11 cm loaf dish with paper towel and place bacon across paper towel.
7. Cover with paper towel and cook for 3-5 minutes on HIGH.
8. Remove top layer of paper towel.
9. Pour in chicken mixture. Refrigerate overnight.
10. Turn out and slice. Serve with Melba toast.

SEASONED CHICKEN PARCELS

Serves 4

3 spring onions, chopped finely
1/2 cup fresh (white) bread crumbs
1 clove garlic, minced
1 egg yolk
1/2 cup pine nuts, chopped finely
100 g smoked bacon

3/4 cup vintage cheddar, grated
2 tablespoons finely chopped fresh
basil
2 large chicken breasts
20 g melted butter

1. Mallet chicken breasts until flat.
2. Mix all other ingredients in a small bowl.
3. Place mixture in the centre of the chicken breast.
4. Roll and tie chicken with string so as no filling is exposed.
5. Place in casserole dish and brush with butter.
6. Cook 16 minutes on MEDIUM HIGH. Turn over halfway during cooking.

TANDOORI CHICKEN

Serves 4-6

2 fresh red chillies, seeded
1 onion
2 cloves garlic, crushed
2 teaspoons crushed ginger
2 tablespoons lemon juice
2 teaspoons ground cumin
1/2 teaspoon black pepper
3 teaspoons ground coriander
2 whole cloves

1/4 teaspoon cinnamon
1 bay leaf
1/2 teaspoon turmeric
1/2 teaspoon nutmeg
2 teaspoons paprika
6 chicken thighs, skin removed
200 g low-fat yoghurt

1. Puree chillies, onion, garlic, ginger and lemon juice until smooth.
2. Mix cumin, pepper, coriander, cloves, cinnamon, bay leaf, turmeric, nutmeg and paprika in a small bowl.
3. Cook for 1 minute on HIGH, stirring halfway through cooking. Remove bay leaf and cloves.
4. Combine chilli mixture, spices and yoghurt together. Spread over chicken.
5. Cover and marinate overnight, stirring occasionally.
6. Place on a roasting rack, cook for 19-21 minutes on MEDIUM HIGH. Turn over halfway through cooking.
7. Serve with boiled rice.

CHICKEN AND MACARONI BAKE

Serves 4-6

No. 15 chicken
20 g butter, melted
2 cups macaroni
1/4 cup plain flour
300 mL sour cream
1 cup chicken stock
100 g vintage cheddar cheese
100 g mozzarella cheese
100 g romano cheese
1 tablespoon chopped parsley

1. Brush chicken with butter melted for 20 seconds on HIGH. Place on a roasting rack. Cook for 30-32 minutes on MEDIUM HIGH, turning halfway through cooking. Cool.
2. Place macaroni in a large bowl. Cover with 4 cups hot water. Cook for 20-22 minutes on HIGH or until pasta is tender. Drain.
3. Remove flesh from chicken.
4. Mix together plain flour, sour cream and chicken stock.
5. Combine chicken, macaroni, sauce and cheese. Place in a large short sided casserole dish and cook for 12-14 minutes on MEDIUM HIGH.
6. Sprinkle with parsley.
7. Serve immediately with a tossed salad.

APRICOT CHICKEN

Serves 4

1000 g chicken breast fillets, cubed
2 packets French onion soup
2 tablespoons plain flour
500 mL apricot nectar
400 g dried apricot, halves

1. Toss chicken in combined French onion soup and plain flour.
2. Place in a 3-litre casserole dish and cover with a glass lid.
3. Cook chicken for 13-15 minutes on MEDIUM HIGH. Stir.
4. Add apricot nectar and apricots.
5. Cook, covered, for 13-15 minutes on MEDIUM HIGH.
6. Stir and stand, covered 5 minutes before serving.
7. Serve hot with pasta.

HONEY CHICKEN LEGS

Serves 4

250 mL soy sauce
4 tablespoons honey
1 tablespoon lemon juice
1 clove garlic, crushed
1/2 teaspoon freshly grated ginger
2 tablespoons oil
8 large chicken legs
sesame seeds

1. Combine soy sauce, honey, lemon juice, garlic, ginger and oil in a small bowl. Pour over chicken and marinate for 2-3 hours.
2. Sprinkle with sesame seeds.
3. Arrange chicken legs on a roasting rack. Cook for 16-18 minutes on MEDIUM HIGH, turning over halfway through cooking.

CHICKEN CACCIATORE

Serves 6

6 chicken thighs
1/4 cup flour
1 tablespoon Season All salt
1 onion, sliced
30 g butter
1 clove garlic, crushed
2 tablespoons tomato paste
440 g can peeled tomatoes
2 chicken stock cubes
1/2 cup white wine
1 green capsicum, thinly sliced
6 black olives, sliced

1. Place chicken, flour and Season All salt into a freezer bag. Toss until chicken is coated.
2. Combine chicken thighs, any flour remaining in bag, onion, butter, garlic, tomato paste, juice from tomatoes, stock cubes and white wine in a 3-litre casserole dish.
3. Cover and cook for 22-26 minutes on MEDIUM HIGH. Stir 2-3 times during cooking.
4. Add capsicum and chopped tomatoes. Cover and cook a further 10-12 minutes on MEDIUM HIGH.
5. Garnish with black olives.

CRUNCHY CAMEMBERT CHICKEN

Serves 6

125 g camembert cheese, finely chopped
2 rashers bacon, finely chopped
1/2 cup toasted, slivered almonds
2 tablespoons seeded mustard
No.15 chicken
2 tablespoons honey

1. Mix camembert, bacon, almonds and 1 tablespoon mustard together.
2. Press camembert mixture between skin and flesh of chicken.
Tie chicken legs together.
3. Mix remaining mustard and honey. Brush over chicken.
4. Place breast side down on a roasting rack, cook for 30-32 minutes on MEDIUM HIGH. Turn over halfway through cooking.
5. Allow to stand covered with foil for 10 minutes before serving.

CHICKEN FILLET BURGERS

Serves 4

3 chicken breast fillets
1 pkt of chicken coating mix
30 g melted butter

TOPPING 1 HAWAIIAN

1 slice ham, sliced in half
2 slices pineapple, sliced in half
3 slices cheddar cheese

TOPPING 2 MEDITERRANEAN

4 pieces of procecuttio
**4 pieces of marinated vegetables such
as eggplant or roast capsicum**
1/4 cup grated vintage cheese
1/4 cup Parmesan cheese

1. Brush fillets with butter.
2. Place chicken and seasoning mix into a freezer bag. Toss to coat chicken.
3. Place chicken fillets onto a roasting rack.
4. Cook for 8-10 minutes on MEDIUM HIGH, turning halfway through cooking.
5. Layer topping on chicken, finishing with cheese.
6. Cook for 4-6 minutes on MEDIUM.
7. Serves on a roll with salad.

ROAST CHICKEN

Serves 4

No.15 chicken
30 g butter, melted
Season All salt

1. Wash and dry chicken well.
2. Tie legs of chicken together with string.
3. Place breast-side down on a roasting rack.
4. Baste with butter and sprinkle with Season All salt.
5. Cook for 16-18 minutes on MEDIUM HIGH.
6. Turn chicken over. Baste with butter and sprinkle with Season All salt.
7. Cook a further 16-18 minutes on MEDIUM HIGH.
8. Allow to stand covered with foil for 10 minutes before serving.

SEAFOOD

PAELLA

Serves 8

3 cups brown rice
6 cups chicken stock
1 tablespoon olive oil
2 cloves garlic, crushed
1 onion, chopped
4 ripe tomatoes, chopped
1/4 cup tomato paste
1 cup frozen peas
1 red capsicum, diced
1 green capsicum, diced

1/2 teaspoon turmeric
paprika
2 cups white wine
1 kg fish fillets, cubed
24 green prawns, peeled with tails intact and deveined
2 calamari tubes, sliced into rings
6 mussels

1. Combine rice and chicken stock together in a large casserole dish. Cook for 45-50 minutes on HIGH, until tender.
2. Combine oil, garlic and onion together in a small bowl. Cook for 2-3 minutes on HIGH.
3. Stir in tomatoes and tomato paste. Cover and cook for 3-5 minutes on HIGH, stirring halfway through cooking.
4. Stir in peas, capsicums, turmeric and paprika. Cook for 5-6 minutes on HIGH, stir in cooked rice.
5. In a large bowl, heat white wine for 4-5 minutes on HIGH. Add fish fillets. Cover and cook for 4-6 minutes on MEDIUM. Remove fish.
6. Stir in prawns and calamari. Cover and cook a further 8-10 minutes on MEDIUM until prawns turn pink. Remove from wine.
7. Place mussels in remaining white wine. Cook for 3-5 minutes on MEDIUM HIGH, until mussels open.
8. Gently fold seafood into rice mixture.
9. Cover and reheat Paella for 14-16 minutes on MEDIUM.
10. Serve with French bread.

CHEESY SALMON CANNELLONI

Serves 4-6

1 large packet cannelloni
250 g ricotta cheese
90 g cheddar cheese
salt and pepper to taste
2 eggs lightly beaten
210 g red salmon, drained with bones removed
2 teaspoons lemon juice
2 tablespoons fresh parsley, chopped
2 tablespoons of extra cheddar cheese
375 g jar pasta sauce

1. Combine ricotta cheese, cheddar cheese, salt and pepper, eggs, salmon and lemon juice and mix well.
2. Place a spoonfuls of salmon mixture into cannelloni shells until full.
3. Place in a single layer in a shallow dish.
4. Pour pasta over cannelloni and smooth over with the back of a spoon to ensure all sections of pasta are covered with sauce.
5. Cook for 14 minutes on MEDIUM HIGH.
6. Remove dish and sprinkle with extra cheese. Continue cooking on MEDIUM HIGH for a further 2-4 minutes.
7. Sprinkle with chopped parsley to serve.

GARLIC PRAWNS

Serves 4

24 green king prawns
3 tablespoons butter
3 cloves garlic, crushed
1 tablespoon chopped parsley

1. Peel and devein prawns, leaving tails in tact.
2. Combine butter and garlic. Cook for 1 minute on HIGH.
3. Stir in prawns and cook for 4-6 minutes on MEDIUM, tossing every 2 minutes.
4. Serve in individual dishes sprinkle with parsley.

THAI SCALLOPS WITH VERCAMILLI NOODLES

Serves 4

500 g scallops	1 teaspoon caster sugar
2 tablespoons butter	2 tablespoons sweet Indonesia soy sauce
2 cloves garlic	1 red hot chilli
1 tablespoon chopped lemon grass	200 g vercamilli noodles
1 tablespoon fresh chives, chopped	5 cm piece of fresh ginger, minced
1 tablespoon fish sauce	
1 teaspoon sesame oil	

1. In a large bowl combine sesame oil, butter, chilli and garlic. Cook for 2 minutes on HIGH.
2. Stir in sugar, soy sauce, ginger, lemongrass, fish sauce and scallops. Stir well.
3. Cook for 10-12 minutes on MEDIUM, stirring twice during cooking.
4. Place vercamilli in hot water, and let stand until noodles are transparent and have collapsed.
5. Serve scallops on a bed of noodles, sprinkled with coriander and chives.

SEAFOOD LAKSA

Serves 4-6

1 tablespoon lemon grass	1 tablespoon fish sauce
270 mL coconut cream	1 packet of bean shoots
2 fish fillets or 300 g king prawns or both	2 cloves garlic minced
1 tablespoon oil	1 packet of vercamelli noodles
1-2 tablespoons Laksa paste	4 cups fish stock

1. In a large bowl cook Laksa paste, oil, lemon grass, and garlic for 1 minute on HIGH stirring once during cooking.
2. Add fish sauce, fish stock and cook for 3 minutes on HIGH.
3. Add cubed fish and or deveined prawns and cook for 7 minutes on MEDIUM. Stir through coconut cream and cook for a further 5 minutes on MEDIUM.
4. Add noodles to a large bowl of boiling water and let stand for 5-10 minutes, or until noodles collapse.
5. In a serving bowl place bean shoots, noodles and then Laksa soup.
6. Garnish with freshly torn coriander and fried onion flakes.

SMOKED SALMON TAGLIATELLE

Serves 4

250 g tagliatelle pasta	2 cloves fresh garlic
60 g butter	2 small shallots, finely sliced
100 g smoked salmon	600 g thickened cream
200 g snow pea, trimmed and sliced	1 tablespoon fresh dill
100 g button mushrooms, finely sliced	1 cup parmesan cheese

1. Place tagliatelle in a large bowl with 5 cups of hot tap water. Cook for 14-16 minutes on HIGH, stirring halfway.
2. In a large bowl cook garlic, butter and shallots for 1 minute on HIGH.
3. Add button mushrooms, and cook for a further 2 minutes on HIGH.
4. In a large shallow dish combine vegetables, pasta, cream, smoked salmon, snow peas and dill. Stir gently until pasta is well coated.
5. Heat for 5 minutes on MEDIUM.
6. Sprinkle Parmesan cheese over pasta and heat for 3 minutes on HIGH.

PRAWN CREOLE

Serves 4

1 tablespoon butter	1 cup chicken stock
1 medium onion, chopped	1 tablespoon parsley
1 capsicum, chopped	2 teaspoons sugar
1 stick celery, sliced	1/2 teaspoon salt
2 tablespoons flour	1/2 teaspoon chilli powder
425 g can whole tomatoes	500 g green prawns, peeled and deveined
1/2 cup tomato paste	

1. In a large bowl, combine butter, onion, capsicum and celery. Cook for 4-5 minutes on HIGH.
2. Stir in flour, tomatoes, tomato paste, chicken stock, parsley, sugar, salt and chilli powder; mix well.
3. Cook, uncovered, for 5 minutes on HIGH, stirring once.
4. Add prawns and cook for 13-15 minutes on MEDIUM, stirring twice. Serve with rice.

SEAFOOD LASAGNE

Serves 6-8

125 g butter
1½ cups plain flour
1 teaspoon dry mustard
4 cups milk

500 g seafood marinara
1 packet precooked lasagne noodles
1½ cups grated tasty cheese

1. In a large bowl, melt butter for 1-2 minutes on HIGH.
2. Stir in flour and dry mustard. Cook for 1½ minutes on HIGH.
3. Gradually stir in milk. Cook for 4-6 minutes on HIGH or until sauce is thick. Stir every 2 minutes.
4. Stir in marinara. Cook for 4-6 minutes on MEDIUM.
5. Dip noodles, individually into a large bowl of boiling water.
6. Layer noodles over base of a 2-litre rectangular casserole dish.
7. Cover noodles with ⅓ marinara sauce and ½ cup cheese. Repeat process, ending with marinara sauce and cheese.
8. Cook for 17-19 minutes on MEDIUM.
9. Allow to stand for 10 minutes before serving.

SESAME PRAWNS

Serves 4

24 green king prawns (approx. 1 kg)
¼ cup port
¼ cup oil
¼ cup chopped parsley
3 shallots, finely chopped
lemon pepper to taste
½ cup toasted sesame seeds
6 bamboo skewers

1. Peel prawns, leaving tails intact, and devein. Place in a shallow dish.
2. Combine port, oil, parsley, shallots and lemon pepper. Pour over prawns. Marinate for 1-2 hours.
3. Thread 3-4 prawns onto each bamboo skewer. Coat in sesame seeds.
4. Place skewers on a roasting rack. Cook for 8-10 minutes on MEDIUM. Turn over halfway.
5. Serve with satay sauce and rice.

CRAB MORNAVY

Serves 6

350 g fresh crabmeat or 2 x 170 g cans crab meat, drained
5 cloves garlic, crushed
60 g butter
⅓ cup plain flour
½ teaspoon dry mustard
2 cups milk

1 onion, finely chopped
½ cup grated cheese
4 tablespoons tomato sauce
½ teaspoon tabasco
2 teaspoons Worcestershire sauce
3 tablespoons cream

1. In a large bowl, melt butter and garlic for 1 minute on HIGH. Stir in flour and mustard. Cook for a further 1 minute on HIGH.
2. Gradually stir in milk. Cook for 3-5 minutes on HIGH, stirring every 2 minutes.
3. Stir in onion, crab meat, salt and pepper, ¼ cup cheese, tomato sauce, tabasco, Worcestershire sauce and cream.
4. Place into a 1-litre serving dish. Sprinkle with remaining cheese.
5. Cook for 8-10 minutes on MEDIUM.
6. Serve in volavaunt shells with a garden salad.

GARLIC MUSSELS

Serves 4 as entree

250 g mussels
250 g New Zealand mussels
1 cup wine
2 cups water
1 clove garlic, crushed

GARLIC BUTTER
2 tablespoons butter
2 tablespoons olive oil
2 cloves garlic, crushed
pepper

1. Wash mussels under running water; remove all traces of mud, seaweed and barnacles with brush or knife; remove beards. Discard cracked, broken or open mussel shells.
2. In a large bowl, cover mussels with wine, water and garlic. Cook for 14-16 minutes on MEDIUM or until open, removing from liquid as they open. Discard unopened mussels.

GARLIC BUTTER

1. Melt butter in jug for 30 seconds on HIGH, add oil, garlic and pepper. Pour ½ garlic sauce over mussels; toss well.
2. Arrange mussels in serving bowl and pour remaining sauce over mussels.

SQUID IN TOMATO AND WINE SAUCE

Serves 6

500 g squid tube
1/2 teaspoon meat tenderiser (optional)
1 tablespoon cornflour
1 tablespoon olive oil
1 spring onion, chopped

1 clove garlic, crushed
410 g can tomato purée
1/4 cup dry white wine
2 tablespoons tomato paste
1 tablespoon chopped fresh basil

1. Cut squid tube into rings. Sprinkle with combined meat tenderiser and cornflour. Refrigerate for 30 minutes.
2. Combine oil, onion and garlic. Cook for 1 minute on HIGH.
3. Stir in tomatoes, white wine and tomato paste. Cook for 5-6 minutes on HIGH.
4. Stir in squid. Cook for 8-10 minutes on MEDIUM, tossing every minute until squid is firm.
5. Sprinkle with fresh basil.
6. Serve with French bread and tossed salad.

BOUILLABAISSE

Serves 8

6 mussels
750 g scallops
500 g green prawns, peeled and deveined
500 g firm fish fillets, cut into bite-size pieces
5 crab sticks, sliced
6 oysters
1 tablespoon olive oil
1 onion, finely chopped

1 clove garlic, crushed
1 1/2 cups fish stock
425 g can tomatoes, puréed
1/2 cup white wine
2 tablespoons tomato paste
1/4 teaspoon turmeric
grated rind of 1 lemon
salt and pepper
basil

1. Wash and clean seafood.
2. Cook oil, onion and garlic in a large casserole dish for 1-2 minutes on HIGH.
3. Stir in fish stock, tomatoes, white wine and tomato paste. Cover and cook for 8 minutes on HIGH, stirring halfway through cooking.
4. Place mussels into hot stock, cover and simmer for 4-6 minutes on MEDIUM HIGH or until mussels open. Discard any which stay closed.
5. Stir in scallops, prawns, turmeric, lemon rind, salt and pepper. Cover and cook for 5-6 minutes on MEDIUM HIGH.
6. Stir in fish fillets, crab sticks and oysters. Cover and cook for 10-12 minutes on MEDIUM HIGH or until fish flakes.
7. Garnish with fresh basil.

AVOCADO SCALLOPS

Serves 4

4 avocados, halved
500 g scallops, halved
2 tablespoons butter
1 onion, finely chopped
1/2 teaspoon cumin
1/2 teaspoon coriander
1/2 teaspoon turmeric
1/2 cup cream
1 tablespoon fresh chives, chopped
2 tablespoons mozzarella cheese, grated
1 teaspoon paprika
Lemon juice

1. Halve avocados, remove seed and brush with lemon juice to prevent browning.
2. In a large bowl, combine butter, onion, cumin, coriander and turmeric. Cover and cook for 5-6 minutes on HIGH.
3. Stir in cream, blending well.
4. Add the scallops to the mixture and cook for a further 14-16 minutes on MEDIUM. Stir during cooking and after cooking.
5. Scoop mixture into advocardo halves. Sprinkle with mozzarella and paprika.
6. Cook for 1 minute on HIGH or until cheese has melted.
7. Garnish with Chives, serve hot.

VEGETABLES

CAULIFLOWER AU GRATIN

Serves 4-6

500 g cauliflower florets
30 g butter
2 tablespoons flour
1 cup milk
1 teaspoon mustard
1/2 cup grated cheese
paprika

1. Place cauliflower in a flan dish. Cover and cook for 4-6 minutes on HIGH, until tender. Drain.
2. Melt butter in a Pyrex jug for 30-40 seconds on HIGH.
3. Stir in flour. Cook for 1 minute on HIGH.
4. Gradually stir in milk and mustard. Cook for 2-2½ minutes on HIGH, stirring every minute.
5. Stir in cheese until melted.
6. Pour over cauliflower. Sprinkle with paprika.
7. Cook for 2-4 minutes on MEDIUM HIGH.

EASY HOME-MADE RICE RISOTTO

Serves 6-8

1 onion, diced
60 g butter
4 rashers bacon, diced
(or 1 cup cooked chicken or ham)
3 chicken or beef stock cubes
2 cups boiling water
1 cup long-grain rice, washed well
1 cup assorted finely chopped vegetables,
e.g. carrots, zucchinis, mushrooms

1. Place onion, butter and bacon in large casserole dish. Cook for 3-4 minutes on HIGH. Stir well.
2. Dissolve stock cubes in boiling water; add to onion and bacon. Add all other ingredients. Cover with a lid and cook for 23-25 minutes on HIGH. Do not stir while cooking.
3. At the end of this time, all the liquid will have been absorbed.
4. Leave to stand for 5 minutes and stir with a fork before serving.

SCALLOPED POTATOES

Serves 4-6

3 large potatoes (approx. 500 g), peeled and sliced thinly
1/4 cup water
1 large onion, sliced
200 g carton light sour cream
1 egg
90 g cheddar cheese, finely grated
paprika

1. Place potatoes in a round or oval shallow dish, add water, cover, and cook for 6-8 minutes on HIGH.
2. Drain off water.
3. Arrange sliced onion over potatoes.
4. Combine sour cream and egg. Mix well and pour over potatoes. Sprinkle with cheese and a little paprika if desired.
5. Cook uncovered, 6 minutes on MEDIUM HIGH.

HONEY CARROTS

Serves 4

500 g carrots, sliced lengthwise
60 g butter
1 tablespoon honey
1 teaspoon garlic, minced
1 teaspoon sesame seeds

1. Combine all ingredients in a casserole dish.
2. Cover and cook for 5-6 minutes on HIGH.
3. Stand covered for 3 minutes before serving.
4. Sprinkle with toasted sesame seeds.

VEGETABLE PLATTER

Serves 4

200 g carrots, sliced
200 g broccoli, cut into florets
100 g zucchinis, sliced

1. Arrange vegetables in a shallow dish with the harder vegetables positioned around the outside and the softer vegetables in the centre.
2. Cover with a lid or plastic wrap.
3. Cook for 4-6 minutes on HIGH.
4. Stand covered for 3 minutes, before serving.

POTATO, AVOCADO AND ONION SALAD

Serves 6

1 kg small new potatoes
1 large onion, sliced into rings
1 tablespoon caster sugar
1 tablespoon butter
1/2 cup mayonnaise
150 mL sour cream
black pepper
1 large avocado, cubed
chives

1. Cut unpeeled potatoes in half. Place in a large dish and cover with water. Cook, covered with a lid, for 14-16 minutes on HIGH (potatoes should be tender but holding their shape). Drain.
2. Place onion rings, caster sugar and butter in a Pyrex dish. Cook for 4-6 minutes on HIGH, stirring twice.
3. Combine mayonnaise, sour cream and black pepper. Pour over potatoes.
4. Toss in onions and avocado; sprinkle with chives.

CHOKOS WITH SOUR CREAM AND BACON

Serves 4-6

2 rashers bacon, chopped
3 medium chokos (500 g), peeled, cored and thinly sliced
150 mL sour cream
1/4 teaspoon dried basil leaves
1/4 teaspoon dried oregano leaves
1/2 cup grated tasty cheese
6 shallots, chopped

1. Cook bacon in a large bowl for 2-3 minutes on HIGH. Drain on absorbent paper.
2. Add chokos to bacon fat in bowl; cover and cook for 8-10 minutes on HIGH or until tender.
3. Combine sour cream, basil, oregano, cheese and shallots with chokos.
4. Sprinkle with bacon.
5. Cook for 1-2 minutes on HIGH.

MINISTRONE

Serves 6

60 g butter
2 onions, peeled and chopped
3 carrots, finely chopped
1 potato, peeled and chopped
3 sticks celery, chopped
2 zucchinis, chopped
1/2 cup pasta shells
3 cups beef stock
2 x 400 g cans peeled tomatoes, chopped salt and pepper
parmesan cheese
425 g can drained red kidney beans (optional)

1. Combine butter and onion in a large casserole dish. Cook for 2-3 minutes on HIGH.
2. Add carrots and potato. Cover and cook for 5 minutes on HIGH.
3. Add celery and zucchini. Cover and cook for 3 minutes on HIGH. Add stock, undrained tomatoes, salt and pepper to taste. Cook, covered, for 15-20 minutes on HIGH, stirring occasionally.
4. Serve hot, topped with parmesan cheese.

STUFFED BAKED POTATOES

Serves 4

4 large potatoes
1/4 cup milk
1/4 cup cream
1/2 cup grated cheddar cheese
30 g butter
2 teaspoons dried parsley flakes
1/4 teaspoon dry mustard
paprika

1. Pierce potatoes with a fork; place on turntable. Cook for 10-12 minutes on HIGH. Stand in foil for 5 minutes.
2. Cut a thin slice from top of each potato; scoop out cooked potato with a spoon, leaving a thin shell.
3. Stir milk, cream, half the cheese, butter, parsley, mustard and potato. Mix well until no lumps remain.
4. Spoon mixture into each potato shell. Place on a plate.
5. Sprinkle with remaining cheese and paprika. Cook for 4-5 minutes on HIGH, until cheese is melted.

HOT CURRIED SLAW

Serves 6-8

1/2 large cabbage, finely shredded
1 large carrot, grated
1/2 cup chicken stock
1 onion, peeled and halved
4 whole cloves
2 cloves garlic
2 bay leaves

salt and pepper
60 g butter
2 tablespoons plain flour
1 tablespoon curry powder
3/4 cup cream
1/4 cup dry breadcrumbs
2 teaspoons butter, extra

1. In a large casserole dish, place cabbage, carrot, stock, onion halves with cloves pressed in, garlic, bay leaves, salt and pepper. Cover and cook for 10-12 minutes on HIGH, stirring halfway through cooking.
2. Remove onion and bay leaves.
3. Melt butter for 45 seconds on HIGH in a jug. Stir in flour and curry powder. Cook for 45 seconds on HIGH.
4. Gradually stir in cream. Pour over slaw, then toss. Sprinkle with breadcrumbs and dot with extra butter.
5. Cook, covered for 5-6 minutes on HIGH.
6. Serve hot.

SQUASH WITH YOGHURT

Serves 4-6

500 g squash
200 g carton natural yoghurt
2 teaspoons seeded mustard
ground black pepper

1. Wash and trim squash. Slice thinly, place in a pyrex pie plate.
2. Cover and cook for 4-6 minutes on HIGH, or until just tender. Drain juice prior to adding yoghurt.
3. Combine yoghurt, mustard and pepper and gently fold through the squash.
4. Serve hot.

HONEY GINGERED VEGETABLES

Serves 6

1/2 cup salad dressing
2 teaspoons grated ginger
2 tablespoons honey
1 tablespoon soy sauce
2 tablespoons lemon juice
500 g butternut pumpkin, peeled and thinly sliced
1 cup frozen beans
2 zucchinis, sliced
1/2 cup pecans

1. In a large bowl, heat dressing, ginger, honey, soy sauce and lemon juice for 3-4 minutes on HIGH.
2. Add pumpkin and cook covered 4-6 minutes on HIGH, until just tender.
3. Stir in beans and zucchinis, cook covered a further 3-4 minutes on HIGH.
4. Spoon onto a serving plate. Sprinkle with pecans.

SUNSHINE BRUSSELS SPROUTS

Serves 4

500 g Brussels sprouts
30 g butter
1 small onion, finely chopped
1/2 cup milk
4 egg yolks, lightly beaten (ensure all yolks have broken)
2 tablespoons lemon juice
salt and pepper

1. Place Brussels sprouts into a pie plate.
2. Cover and cook for 3-5 minutes on HIGH.
3. Combine butter and onion in a jug. Cook for 2-3 minutes on HIGH.
4. Blend in remaining ingredients. Cook for 5-6 minutes on MEDIUM until thick, stirring every minute.
5. Pour over Brussels sprouts. Heat for 2-3 minutes on MEDIUM.

POTATOES PIZZAIOLA

Serves 4-6

4 large potatoes
1 tablespoon butter
1 clove garlic, crushed
425 g can tomatoes, roughly chopped
2 teaspoons fresh (or 1/2 teaspoon dried) oregano
ground black pepper

1. Peel and dice potatoes into 1.5 cm cubes, rinse and place in a large bowl with 2 tablespoons of water, cover and cook for 8 minutes on HIGH, stirring halfway through cooking. Drain.
2. In a small bowl, combine butter and garlic and cook for 30 seconds on HIGH.
3. Combine oregano and pepper to garlic mixture.
4. Add tomatoes and garlic mixture to potatoes, ensuring potatoes are well coated.
5. Cook, uncovered, for 10 minutes on HIGH, stirring halfway through cooking.

CAULIFLOWER POLONAISE

Serves 4-6

500 g cauliflower
1 cup peanut butter
2 tablespoons honey
200 mL carton natural yoghurt
1 tablespoon parsley
1/2 cup toasted pine nuts

1. Trim cauliflower and break into florets.
2. Place cauliflower in a 20 cm pie plate. Cover and cook for 4-6 minutes on HIGH.
3. Heat peanut butter and honey in a large jug for 40 seconds on HIGH.
4. Add yoghurt to the mixture, stir well.
5. Pour over cooked cauliflower. Sprinkle parsley, eggs and breadcrumbs and sprinkle over peanut butter sauce.
6. Cook for 3-4 minutes on HIGH or until hot.
7. Serve hot with toasted pine nuts sprinkled on top.

PUMPKIN SALAD

Serves 6-8

1 kg pumpkin, peeled and cubed
2 tablespoons water
3/4 cup walnuts
6 shallots, chopped
1/4 cup finely chopped parsley
1/2 teaspoon nutmeg
ground black pepper
1 cup mayonnaise

1. Place pumpkin in large bowl, add 2 tablespoons of water, cover and cook for 10-12 minutes on HIGH or until pumpkin is just cooked, but still firm.
2. Refresh by running cold water over pumpkin. Drain and chill.
3. Mix walnuts, shallots, parsley, nutmeg and pepper with mayonnaise.
4. Fold mayonnaise mixture gently into the pumpkin. Serve chilled.

DESSERTS

CALIFORNIAN APPLE CRUNCH

Serves 6-8

800 g can pie apple
1½ cups White Wings buttercake mix
150 g hard butter, cut into thin slices
3 tablespoons brown sugar
3 tablespoons coconut
3 tablespoons crushed nuts
1 teaspoon cinnamon

1. Place pie apple in a shallow casserole dish.
2. Sprinkle evenly with dry cake mix.
3. Layer sliced butter over cake mix, covering completely.
4. Combine last 4 ingredients and sprinkle over sliced butter.
5. Cook for 10-12 minutes on HIGH.
6. Serve warm with whipped cream.

AUSTRALIAN FRUIT CAKE

Serves 4-6

1 kg mixed fruit	1 cup plain flour, sifted
1 cup brown sugar	1 teaspoon baking powder
250 g butter, chopped	salt
2 tablespoons brandy	½ teaspoon nutmeg
4 eggs, lightly beaten	1 teaspoon cinnamon
2 teaspoons parisienne essence	2 tablespoons brandy, extra

1. Combine the first 4 ingredients in a large bowl. Cover and cook for 5 minutes on HIGH, stirring once. Allow to cool slightly.
2. Stir in eggs and parisienne essence, followed by dry ingredients.
3. Pour into a greased 20 cm cake container.
4. Cook for 10-12 minutes on MEDIUM.
5. Using a 3 cm foil strip, place around the outside of cake plastic container. (This will prevent the outside from overcooking before the centre is cooked.)
6. Cook a further 10-12 minutes on MEDIUM.
7. Stand 5-10 minutes before turning out.
8. Pour over extra brandy. Decorate with extra glacé fruits if desired.

BAKED APPLES

Serves 4

¾ cup walnuts	4 large apples
¼ cup brown sugar	2 tablespoons lemon juice
2 teaspoons mixed spice	30 g butter, melted

1. Place walnuts, sugar and mixed spice in a blender or food processor, process until nuts are finely chopped.
2. Peel and core apples, brush with lemon juice.
3. Brush apples with butter. Toss in walnut mixture until evenly coated.
4. Place in base of a 20 cm pie plate. Fill centre of apples with any remaining walnut mixture.
5. Cook for 4-6 minutes on HIGH. Allow to stand for 5 minutes.
6. Serve with whipped cream.

CHOCOLATE CAKE

2 cups sugar	½ cup oil
¾ cup cocoa	1¾ cups plain flour
1 teaspoon baking powder	2 eggs
1½ cups milk	2 teaspoons vanilla

ICING

125 g butter	125 g philadelphia cheese
1 cup icing sugar	2 dessert spoons cocoa
1 dessert spoon rum	

1. Combine all ingredients together in a large bowl.
2. Beat together for 3 minutes on HIGH.
3. Pour into a greased microwave safe gugelhopf container.
4. Cook for 20-23 minutes on MEDIUM. Allow to stand 5-10 minutes before turning out.
5. Allow to cool before icing.

ICING

1. Beat ingredients together till light and creamy.
2. Ice cake when cool.

CHOCOLATE SELF-SAUCING PUDDING

Serves 4-6

90 g butter
1½ cups self-raising flour
½ cups caster sugar
3 tablespoons cocoa powder
¾ cup milk
150 g dark cooking chocolate, melted
1 cup brown sugar
3 tablespoons cocoa powder, extra
2½ cups boiling water

1. Combine flour, cocoa, caster sugar in a Pyrex bowl. Stir in milk, chocolate and butter. Mix until smooth.
2. In a separate bowl, mix brown sugar, extra cocoa powder and boiling water. Pour over mixture.
3. Cook for 9-11 minutes on HIGH.
4. Stand 5 minutes before serving.
5. Serve hot with ice cream.

BREAD AND BUTTER PUDDING

Serves 4-6

4 slices bread, crusts removed
butter
3 tablespoons caster sugar
¼ cup sultanas
2½ cups milk
½ teaspoon vanilla essence
4 eggs, lightly beaten
3 tablespoons brown sugar
¼ teaspoon nutmeg

1. Spread bread with butter and cut into 2 cm cubes.
2. Place bread, sugar and sultanas in a 1.25-litre pudding bowl.
3. Heat milk and vanilla for 3 minutes on HIGH. Gradually whisk into eggs. Cook for 3-4 minutes on HIGH, stirring during cooking, or until thick.
4. Pour over bread mixture.
5. Sprinkle with brown sugar and nutmeg.
6. Cook for 15-20 minutes on MEDIUM LOW.
7. Allow to stand for 5-10 minutes before serving.

CARAMEL RICE PUDDING

Serves 4-6

1 cup rice
3 cups hot water
400 g can condensed milk
1 tablespoon butter
1 tablespoon lemon juice
3 eggs, separated
1 tablespoon vanilla essence
2 tablespoons caster sugar
cinnamon sugar

1. Place rice and water in a large Pyrex bowl. Cook for 12-15 minutes on HIGH, or until tender. Stir halfway. Drain.
2. Mix condensed milk and butter together. Cook for 4-6 minutes on HIGH, stirring every 20 seconds. (Caramel will boil over if not stirred.)
3. Stir cooked rice, lemon juice, egg yolks and vanilla essence into caramel. Pour into a 2-litre pudding bowl.
4. Beat egg whites until stiff, gradually beat in sugar. Spoon over rice pudding.
5. Sprinkle with cinnamon sugar. Cook for 3-5 minutes on MEDIUM.
6. Stand 5 minutes before serving.

CHOCOLATE MOUSSE

Serves 4

200 g cooking chocolate
2 tablespoons water
2 tablespoons rum
¼ cup caster sugar
3 egg whites
300 mL carton thickened cream
extra cream for decoration
30 g chocolate, grated

1. Place chocolate, water and rum in a large heatproof bowl. Melt for 1 minute on HIGH, stirring after 30 seconds. Stir in sugar.
2. Allow mixture to cool, then whip until aerated.
3. Beat egg whites until stiff peaks form.
4. Whip the cream until thick but not stiff. Fold cream and beaten egg whites into chocolate mixture.
5. Divide mixture evenly between four dessert glasses. Refrigerate until set.
6. Serve decorated with cream and chocolate shavings.

QUICK REFERENCE GUIDE

FEATURE	QUICK OPERATION GUIDE
Sensor Instant Reheat	Soup PRESS once to automatically reheat 1 to 4 cups soup.
Sensor Cook	Menu Category and Menu Desserts x1 → Instant Cook START eg. Cake
Express Defrost	Menu Express Defrost x2 → Instant Cook START eg. Chicken Fillets
Easy Defrost	Menu Weight Easy Defrost x4 → 1 0 → Instant Cook START eg. Poultry eg. 1.0kg
More or Less (Sensor Instant Reheat)	Menu For more setting For less setting Soup → Power Level x1 or Power Level x2 eg. Soup Within 2 seconds
More or Less (Sensor Cook, Express Defrost, Easy Defrost)	Menu Weight* For more setting For less setting Easy Defrost x4 → 1 0 → Power Level x1 or Power Level x2 → Instant Cook START eg. Poultry eg. 1.0kg * Sensor Cook and Express Defrost do not need to enter weight.
Variable Cooking Control	To Soften Cream Cheese or Butter for 40 seconds on M•LOW. Cooking Time 4 0 → Power Level x4 → Instant Cook START
Slow Cook	Cooking Time Slow Cook → 1 3 0 → Instant Cook START eg. 1hour 30min.
Auto Start	To cook a Casserole for 40 minutes on MEDIUM to start at 4:00 pm Start Time Help → 1 → 4 0 0 → Timer Clock Cooking Time → 4 0 0 0 → Power Level x3 → Instant Cook START
Instant Cook	Just One Touch Instant Cook START Within 3 minutes of closing the door
Clock	To set for 11:45 am. Timer Clock x2 → 1 1 4 5 → Timer Clock

SHARP

SHARP

SHARP CORPORATION OSAKA, JAPAN

TINSEA891 WRRZ - J23
PRINTED IN THAILAND